

Technical data sheet

Stand-off bracket

Item no. 6015664

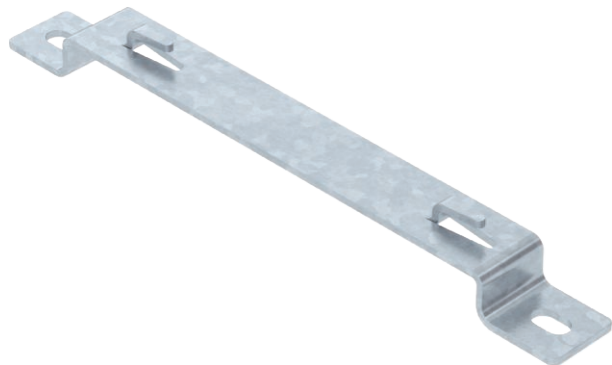

Stand-off bracket for stand-off of mesh cable trays on the floor or on the wall.
GRM mesh cable tray types with side heights of 35, 55 and 105 mm can be mounted onto the spacer clamp.



St	Steel
FT	Hot-dip galvanised

Additional product text, instruction | Screwless fastening of the mesh cable tray on the stand-off bracket.

Master data

Item no.	6015664
Type	DBLG 20 200 FT
Description 1	Spacer clamp
Description 2	for mesh cable tray
Dimension	B200mm
Material	Steel
Material symbol	St
Surface	Hot-dip galvanised
Surface to DIN	DIN EN ISO 1461
Surface symbol	FT
Smallest sales unit (VG)	20,00 Piece
Weight	21,70 kg/100 pc.

Technical data

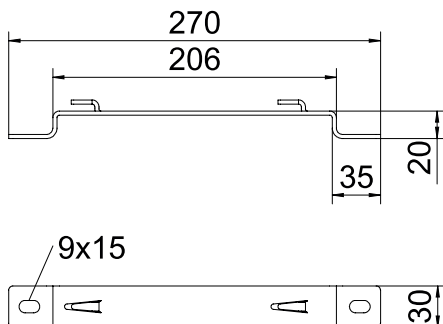

Height	20,00 mm
Dimension B	206,00 mm
Dimension L	270,00 mm
Version	Wall/ceiling clamp, trapezoidal profile
Tray fastening	Retaining lug
Suitable for cable tray	<input type="checkbox"/>
Suitable for cable ladder	<input type="checkbox"/>
Suitable for mesh cable tray	<input checked="" type="checkbox"/>

Technical data sheet

Stand-off bracket

Item no. 6015664



Technical data

Appr. load:

Technical data sheet

Stand-off bracket

Item no. 6015664



Technical data

Appr. load: