

Technical data sheet

Wall bracket AW 80

Item no. 6417779



Heavy-duty wall bracket with welded head plate.



St	Steel
FT	Hot-dip galvanised

Additional product text, instruction | When fastening cable trays and ladders with truss-head bolts of size M6, please order large washers separately (perforation in bracket 9 x ...).

Master data

Item no.	6417779
Type	AW 80 31 FT
Description 1	Wall bracket
Description 2	with welded head plate
Dimension	B310mm
Material	Steel
Material symbol	St
Surface	Hot-dip galvanised
Surface to DIN	DIN EN ISO 1461
Surface symbol	FT
Smallest sales unit (VG)	1,00 Piece
Weight	160,00 kg/100 pc.

Technical data sheet

Wall bracket AW 80

Item no. 6417779



Technical data

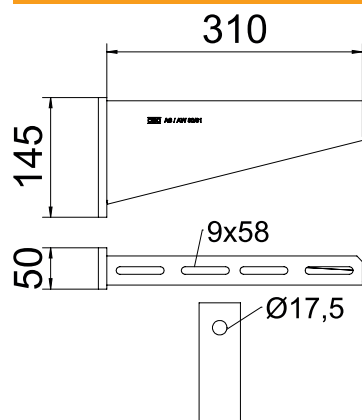

Width	310,00 mm
Side height	145,00 mm
Dimension A	50,00 mm
Dimension B	310,00 mm
Dimension H	145,00 mm
Dimension L	310,00 mm
Hole diameter	17,50 mm
Dimension value	310 x 145
Version	Wall and support brackets
Version	Wall and support bracket
F in kN	8,00 kN
Suitable for maintaining electrical function	<input type="checkbox"/>
Rustproof steel, pickled	<input type="checkbox"/>
Angle range	90,00 - 90,00 °

Technical data sheet

Wall bracket AW 80

Item no. 6417779



Load charts

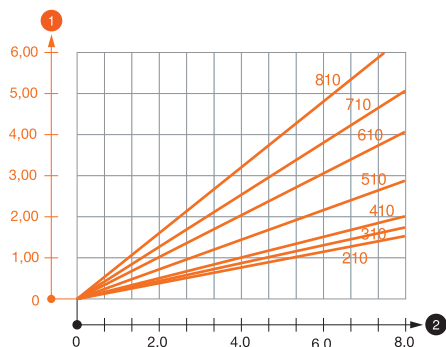

Load values heading_Characteristic anchor values
Heading, load table
Footnote, load table

Characteristic anchor load values for wall bracket AW 80

Wall bracket load

Max. total load $F = \text{cable weight} + \text{cable tray} + \text{bracket}$. The load capacity values increase considerably when used in uncracked concrete. The values given are based on concrete of strength class C20/25. Observe the installation conditions of the DIBt approval (anchors).

Load diagram, bracket type AW 80

1 Bending of the bracket tip at permitted bracket load

2 Permitted bracket load in kN without man load

— Load curve with bracket lengths in mm

Characteristic anchor load values for wall bracket AW 80

Wall fastening		Max. load F [kN]						
		Bracket width [mm]						
	Anchor type	210	310	410	510	610	710	810*
	BZ 12-15-35/110	4,75	4,60	4,50	4,50	4,25	3,80	3,50
SZ-B 18/0x142	7,40	7,60	7,00	7,00	6,60	5,50	5,40	
		* Values with tray width 600						

Max. total load $F = \text{cable weight} + \text{cable tray} + \text{bracket}$. The load capacity values increase considerably when used in uncracked concrete. The values given are based on concrete of strength class C20/25. Observe the installation conditions of the DIBt approval (anchors).

Characteristic anchor load values for wall bracket AW 80

T1	Wall fastening							
T2		Max. load F [kN]						
T3		Bracket width [mm]						
T4	Anchor type	210	310	410	510	610	710	810*
	BZ 12-15-35/110	4,75	4,6	4,5	4,5	4,25	3,8	3,5
	SZ-B 18/0x142	7,4	7,6	7	7	6,6	5,5	5,4
Tsub		* Values with tray width 600						