

Thorsman F80 Installation System

Spacious solutions with room for innovation

Product catalogue 2024



Life Is On

Schneider
Electric

Contents

Installation trunking

Aluminium type INKA	17
Design trunking type DFK.....	39
PVC type TEK	47
PC/ABS type NPT	60

Service poles

Aluminium, POL.....	69
---------------------	----

Service posts

Aluminium, POS	87
----------------------	----

Floor outlet boxes

Type UFB	91
----------------	----

Furniture units

Type SBO.....	105
---------------	-----

Dedicated wiring devices

Type CYB	107
Type MIB	135

Mini-trunking

Halogen-free, type TMK.....	139
-----------------------------	-----

Cable distribution trunking

Aluminium, type FED	143
PVC, type TIR.....	148

Pipe- and cable trunking

Aluminium, type TRL.....	157
--------------------------	-----

VDI devices

Type TDL.....	161
---------------	-----

Cable organisers

Type CBL	165
----------------	-----

Index

Reference number overview	168
---------------------------------	-----



The choice of experienced professionals



With more than 40 years' experience, some 600 million metres of produced trunking, almost 2,000 products in the range, Thorsman F80 has become the preferred choice among generations of professionals. Over the years, Thorsman F80 installation system* has been developed in close cooperation with installers, and their input is highly regarded for continuous updates, additions and adjustments. Today, Thorsman F80 installation system is environmentally optimised, totally integrated, and versatile enough to manage all the challenges of the installer's work day. Job satisfaction is granted by a number of advantages – from the impressive space for large amounts of cables to the tool-less quick-connect technology.

*F80 is the common 80-mm front opening size of the entire Thorsman Installation System.

Line-up of the versatile Thorsman core team

One prominent benefit with the Thorsman F80 installation system is that it is in stock at most suppliers. This means that it is just as easy to update and complement the system, as it is to install and use. In other words, even greater advantages for the specifier, electrician, building owner and tenant. Included in the system are trunking, poles, posts, and floor boxes, all with the same exquisite quality and design.



Trunking

Horizontally or vertically, at any height – install the trunking the way it suits you. Choose between aluminium, halogen-free plastic, PVC or steel.

Floor boxes

Robust and easy-to-mount, plastic or stainless steel. Let the floor boxes blend with the room interior by letting the lid match the floor material.



Posts

Stable and efficient, the posts provide easy, flexible access when power and data are fed on or from underneath the floor.



Quick-couplings

Available in different versions, the quick-couplings all offer smart and fast ways of installing.



Poles

Providing excellent flexibility for the end-user, the poles supply power and network access close at hand.

Thorsman project support

With a simplified production process, we manage short lead time and high service level on products requiring special length or/and color.

Optional length

We keep stock on most frequent aluminum profiles for efficient cutting of products up to 6 m.

Standard colours

Stocked installation trunking type INKA, feeder trunking type FED and service poles type POL comes anodized or powder coated in standard white RAL 9016.

Optional colour

Products (trunking base + front) in aluminum can be powder coated in any RAL color and gloss. To be able to paint and dispatch products at short notice, we stock some of the most frequently used colors.

Use the product reference number (ie "Optional number") followed by the color and gloss code. See tabular below for available colors.

- RAL 9005 gloss 60 Black
- RAL 7022 gloss 72 Anthracite
- RAL 9007 metallic Grey
- RAL 9003 gloss 72 Polar white
- RAL 5022 gloss 72 Blue
- RAL 6029 gloss 72 Green
- RAL 1018 gloss 72 Yellow
- RAL 2003 gloss 72 Orange
- RAL 3003 gloss 72 Red
- RAL 9010 gloss 72 Ebony white

Other colors

Other colors can be offered upon request with additional charge.



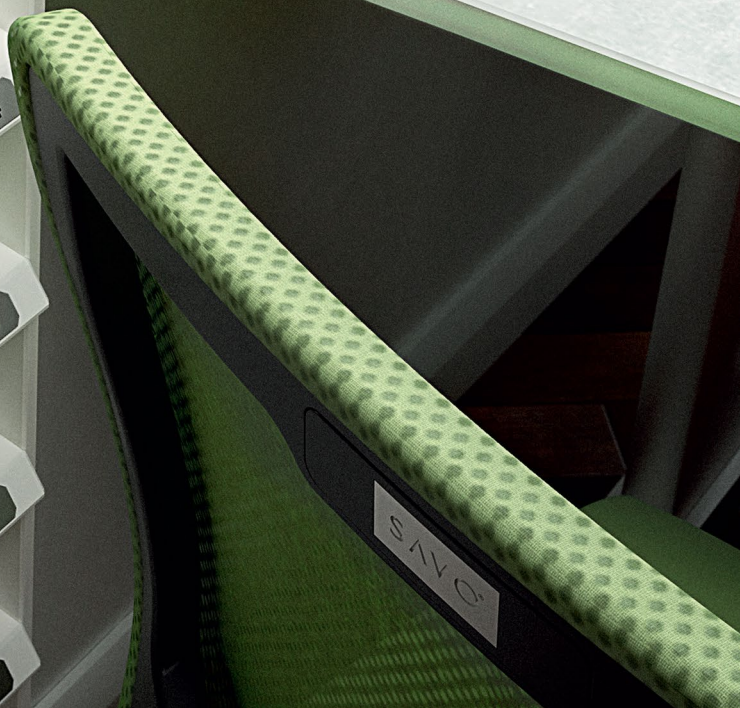
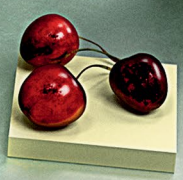

Thorsman Versatile and powerful, from the inside out

Thorsman trunking is a well-proven and highly respected product system. As an example of the renowned Thorsman quality, the TEK-123 trunking alone has sold 3 million metres over the past 10 years. With the versatile F80 range, making robust, high-capacity installations in a cost- and time-efficient way is pure pleasure.



Quick couplings

Make the installation without time-consuming factors like cable stripping and coupling. Get twice as much done and dismount just as easily.

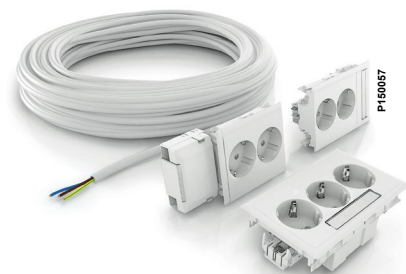

Traditional Push-in/screw

The exact conditions can be difficult to predict. Thorsman trunking is just as friendly when working with traditional cable by the meter.



Add from the c/c 60 world

The F80 design lets you install c/c 60 wiring devices in trunking, poles and post – always with great result.

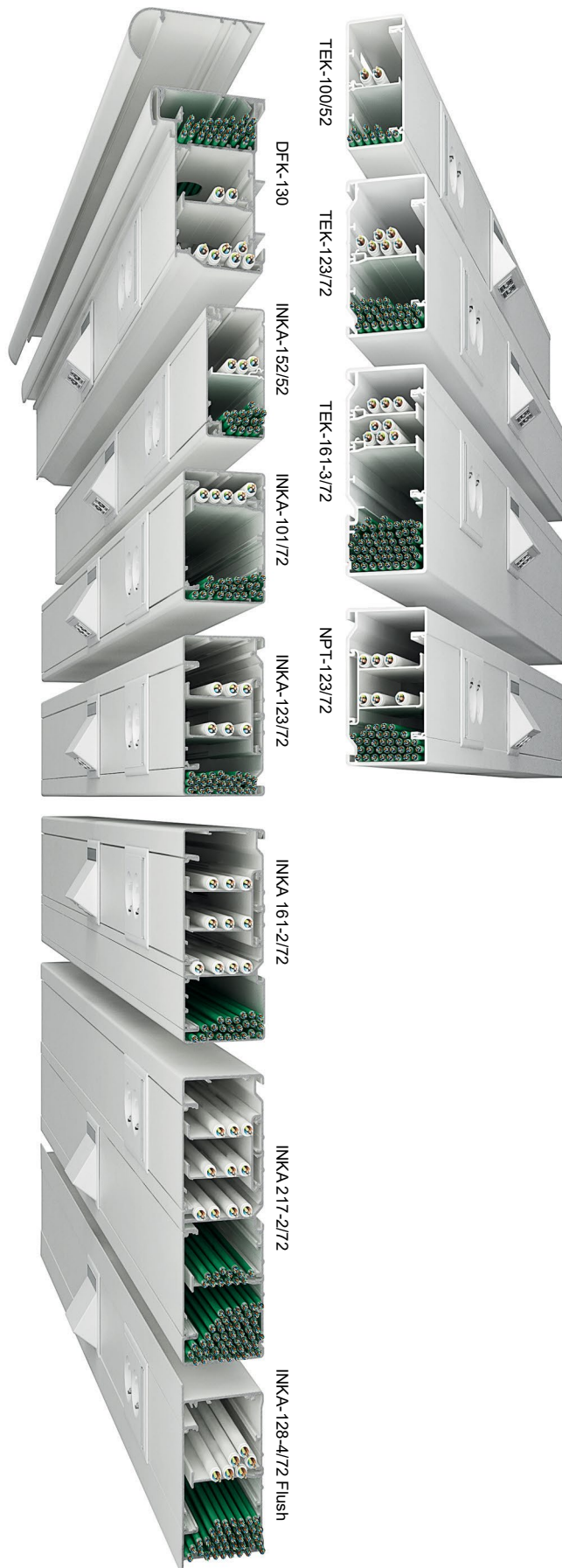



Thorsman trunking – be innovative on site

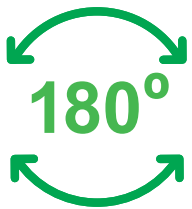

Symmetric
Several types of the trunkings are symmetric and 180° turnable, enabling a correct installation at all times.



Ready to use
There are complete, ready-to-use kits for corners, T- and L-pieces. No cutting is needed, thanks to special front pieces. Just snap and go.



The Thorsman trunking is the fast route to sturdy, flexible and nice-looking installations, also when the room is full of nooks and crannies. The flexibility brings great savings on time and effort.



Universal corner
The system provides robust quality in every detail. The universal corner fits both internal and external corners.

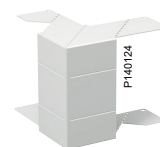

Adjustable corners
The adjustable inner corner pieces suit angles between 90 and 135°, whereas the outer corners fit angles 80-135°. IP40 when mounted directly onto the wall.





Customer Care Center

Whether you need help to select the right product, want to know the price, where to buy or just need professional technical support, we are there for you. Our Customer Care Centers are present in a large number of countries. Go to schneider-electric.com to find your closest center.



Window-sill trunking

Aesthetic trunking that blends with any office interior. For mounting at mid-wall or window-sill level, with integrated ventilation ribs for efficient air flow.



Adjustable bracket with separate ventilation rib holder.



Adjustable bracket. Holder for ventilation rib ordered separately.



Bracket with smooth top surface and separate ventilation rib holder.

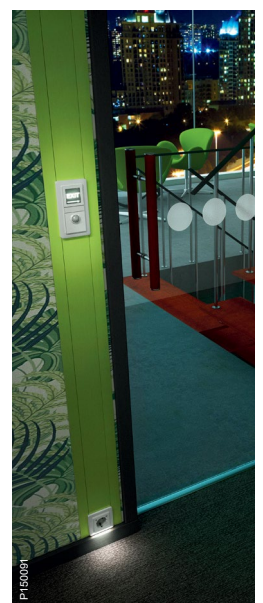

Optional colour

White and anodized aluminium are the most common colours, but in some designs any colour can be ordered on request.



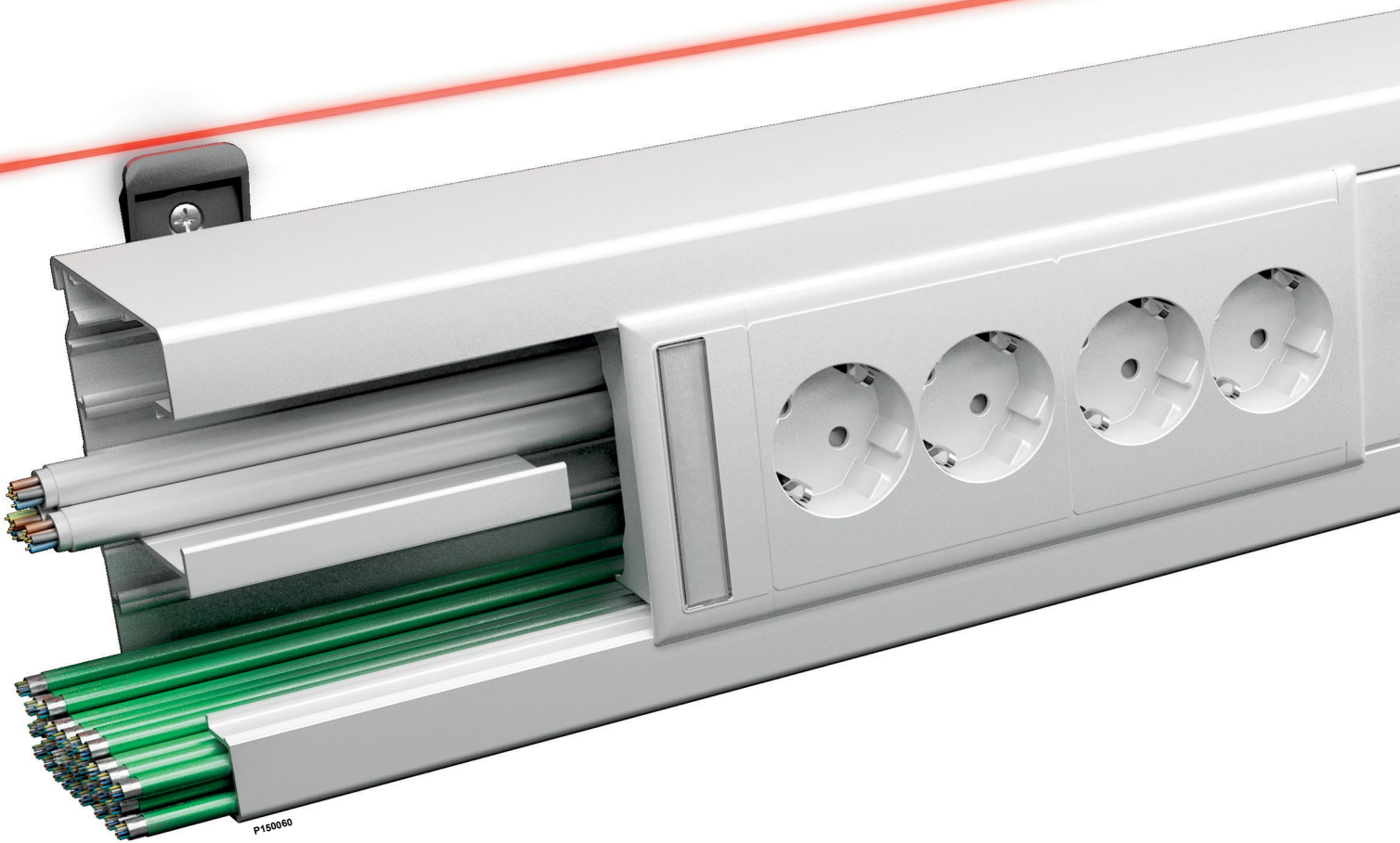

The building blocks of an ingenious trunking system

The well-proven Thorsman trunking range presents a wide range of solutions, allowing safe and easy compatibility with current as well as future systems. The appealing look is kept intact, thanks to the F80 design enabling room to mount c/c 60 wiring devices.

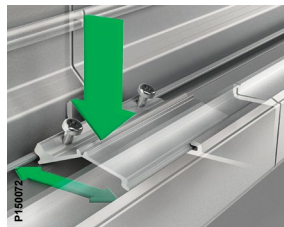
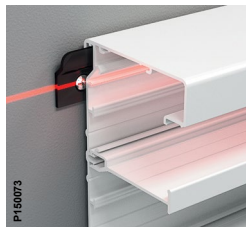

One-man show
After fastening the mounting spacers, perfectly aligned horizontally and max 1000 mm apart, just assemble the trunking – an operation easily carried out by one installer only.

Easy jointing
Easy-to-apply jointing pieces for trunking, corners and L-pieces. Includes two earthing screws.



High capacity
By using separate compartments or cable shelves cables for power, low voltage, tele and data can be managed in the same trunking.



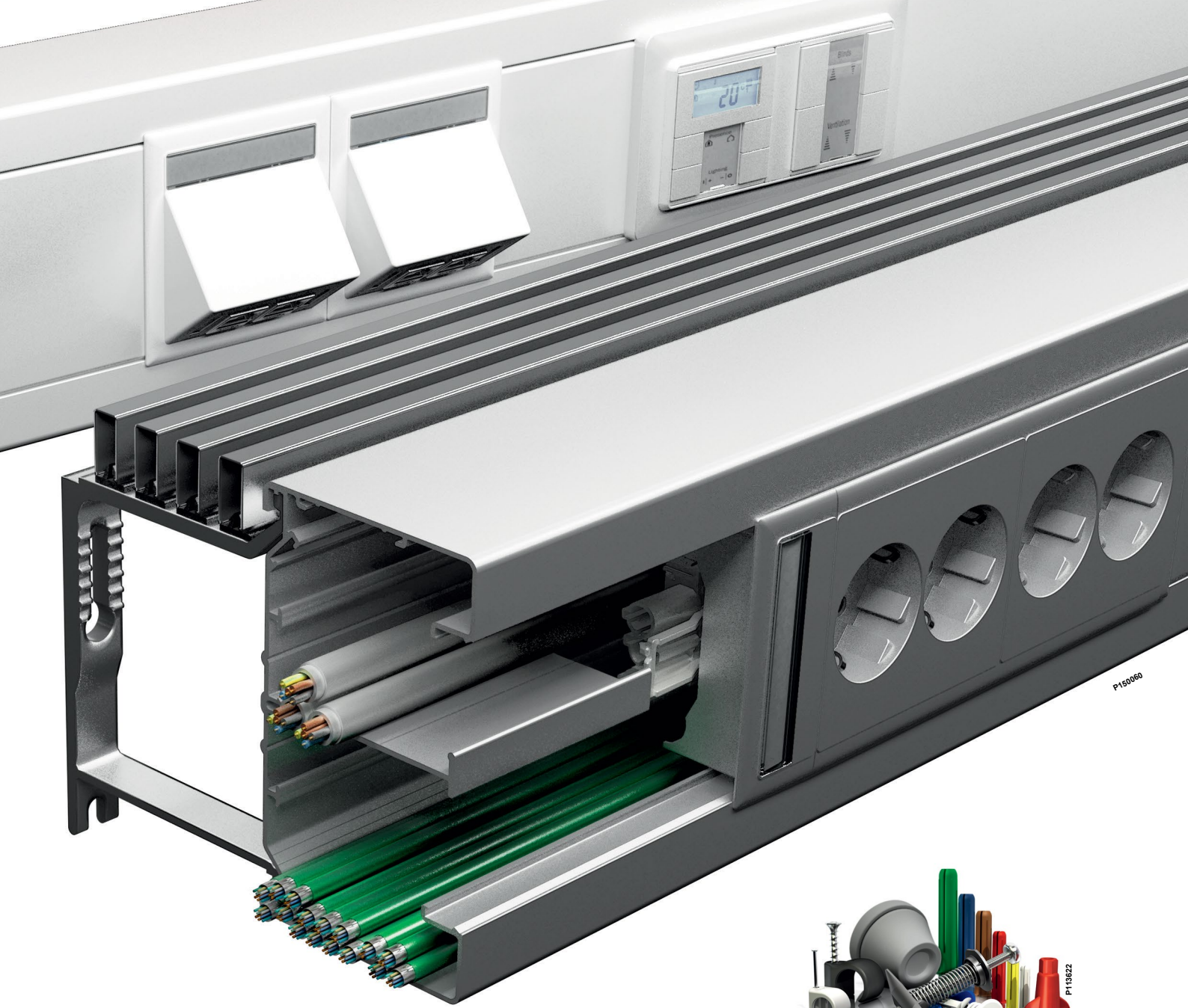

Instruction manuals
All types of trunking are delivered with easy-to-use manuals and clear instructions of how to make the most of the systems and accessories.

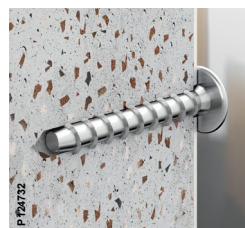

Professional fixing material
Our fixing material has been created for professionals, by professionals. The range includes everything needed for secure fixing in all wall materials.



Sound absorption
When feeding the trunking through a wall, make sure to add sound absorption strips for optimal sound-proofing.



Easy operation
Using a simple and smart front opening tool, you can easily open up the trunking to make adjustments and additions.



Concrete screw
Strong and sturdy screw in electro-plated steel. Various dimensions for concrete and solid brick material.



Cavity fixing
Screw complete with toggle and collar, for secure fastening in board walls 10-26 mm.



Choose the perfect method for every installation

What characterises a truly smart and integrated trunking system? We believe it is the attention to detail, the range of components, and the simplicity of combining them. And of course the overall easiness of the total installation process, regardless of environment. Clever accessories and well-proven operations allow the installer to work fast and efficiently – often with a smile on his face.

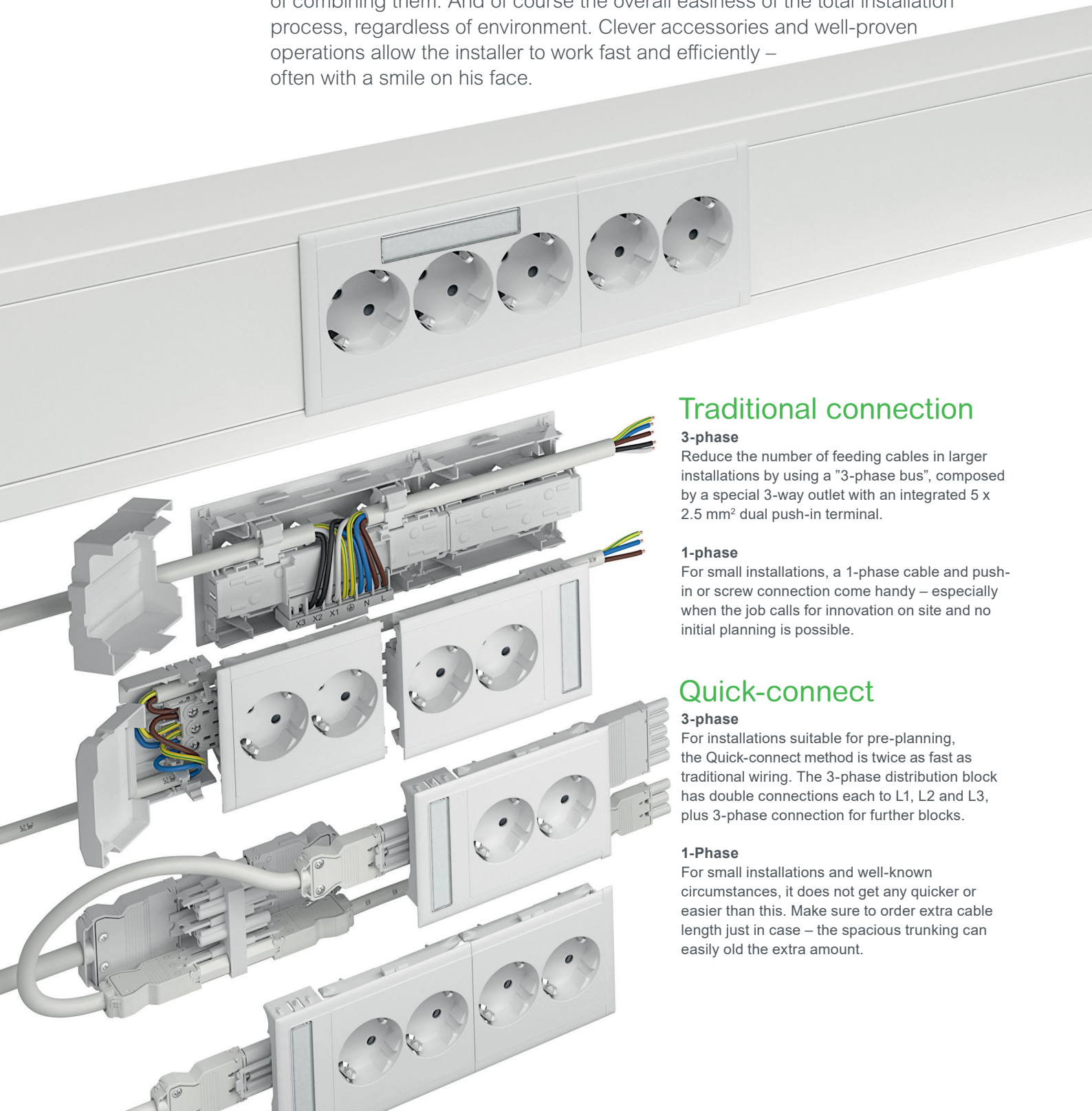

Traditional connection

3-phase

Reduce the number of feeding cables in larger installations by using a "3-phase bus", composed by a special 3-way outlet with an integrated 5 x 2.5 mm² dual push-in terminal.

1-phase

For small installations, a 1-phase cable and push-in or screw connection come handy – especially when the job calls for innovation on site and no initial planning is possible.

Quick-connect

3-phase

For installations suitable for pre-planning, the Quick-connect method is twice as fast as traditional wiring. The 3-phase distribution block has double connections each to L1, L2 and L3, plus 3-phase connection for further blocks.

1-Phase

For small installations and well-known circumstances, it does not get any quicker or easier than this. Make sure to order extra cable length just in case – the spacious trunking can easily hold the extra amount.

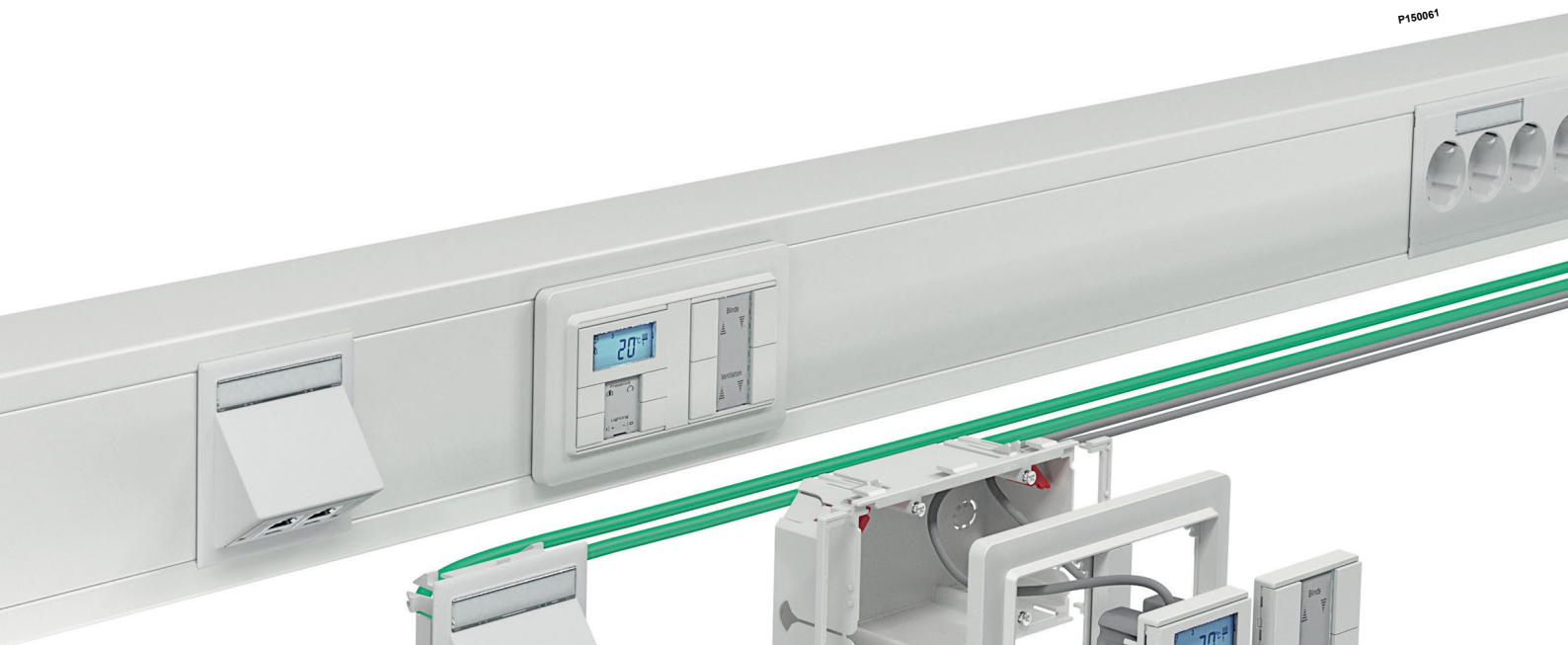

Clear marking

The window allows easy identification of the device. Just loosen and snap back when updating is necessary.

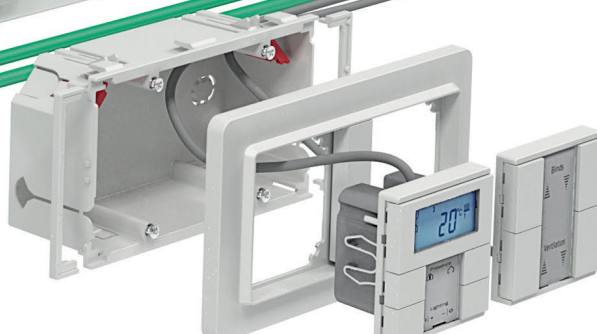

Less planning

With the push-in/screw connector you can work the way you are used to, using cable by the meter. Just grab a cable roll and a box of connectors and you're ready to go. The connector has room for both incoming and outgoing cables, which means you can connect more groups on each phase.



Cat 6a-friendly

Today's shielded Cat 6a network cables are quite stiff and require large bend radius to maintain transmission capacity. The 72-mm depth of the trunking along with the angled CYB outlet vouch for perfect Cat 6a handling.

Work even faster

CYB-PS quick connect devices fits all types of F80 trunking and allow easy installation of 2- or 3-way outlets. Just push in and add the end piece to lock the outlets in position. No extra cabling, no tools – fast and easy.

The MIB boxes

To make the Thorsman Installation System complete, you must be able to find quick, versatile solutions. The MIB box has smart fittings, inlets and cable reliefs, allowing you to install any type of c/c 60 device.

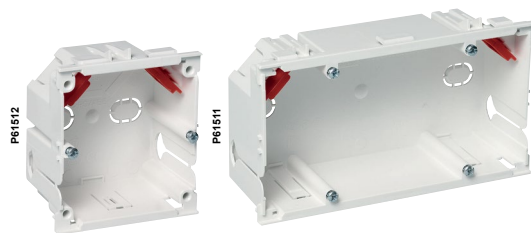

Add functions from the c/c 60 world

Specific environments demand special properties of alarms, building control devices, etc. This is never an issue, as any c/c 60 device fits in the trunking.



CYB dedicated wiring device

With sleek look and smooth feel, all dedicated CYB functions and designs provide excellent properties for environments with high demands on flawless hygiene, such as hospitals and laboratories.



EXIT

INKA aluminium trunking

Evolved from 40 years of installer feedback

Featuring advantages like great cable capacity, shielding opportunities, open customised design, and the largest number of options of all our trunking types, INKA is a class act in aluminium trunking. The elegant finish of anodized aluminium is revealed once the protective film has been peeled off.



Freedom of choice

On special order, the INKA aluminium trunking can be delivered powder-coated in any colour. Just state the RAL or NCS code. Standard lengths are 2.5 metres. However, any length of up to 6 metres can be delivered in any colour on request.



Cable capacity

The INKA trunking offers impressive space. Thanks to the separating shelves, cables for power, low voltage, tele and data can be placed in different compartments of the same trunking.



There is always a right type of INKA



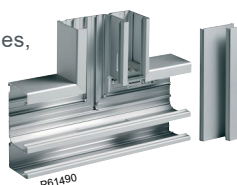

When it comes to performance and flexibility, few alternatives beat INKA. With heights ranging from 100 to 217 mm, outstanding cable capacity, and a large number of accessories, INKA is our most customisable type of trunking.

Aluminium stop end

To be mounted on the end of the trunking. For extra fixation, combine with the extra end piece bracket.





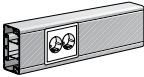
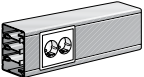
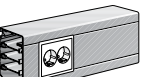
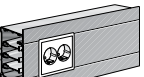



Product Range, type INKA



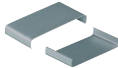

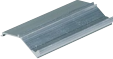

In the matrix: Type Art. No. Material/Finish	 P61397	 P61884	 P61439 P63661	 P61433 P63662	 P61391		
INKA-	Trunking base	Front cover	Internal corner	External corner	Bend, 90°		
152/52 	INKA-U152 5519080 AN 5519082 AO 5519084 AW	FCA-F80 5580080 AN 5580089 AO 5580060 WN 5580069 WR 5580088 AW	INKA-IH152 5575250 AN 5575254 AO Adjustable TTI-IH100 5589150 WR	INKA-LSU152 5575260 AN 5575262 AO Adjustable TTI-YH100 5589500 WR	INKA-LSU152 5575270 AN ↑ 5575274 AW ↑		
101/72 	INKA-U101 5504000 AN 5504002 AO 5504003 AW	FCA-F80 5580080 AN 5580089 AO 5580060 WN 5580069 WR 5580088 AW	INKA-IH101 5504100 AN 5504102 AO 5504103 AW	INKA-YH101 5504110 AN 5504112 AO 5504113 AW	INKA-LSU101 5504123 AW ↑ INKA-LSN101 5504133 AW ↓		
123/72 	INKA-U123 5507000 AN 5507002 AO 5507003 AW	FCA-F80 5580080 AN 5580089 AO 5580060 WN 5580069 WR 5580088 AW	INKA-IH123 5507100 AN 5507102 AO 5507103 AW Adjustable TTI-IH123 5589170 WR	INKA-YH123 5507110 AN 5507112 AO 5507113 AW Adjustable TTI-YH123 5589520 WR	INKA-LS123 5507120 AN 5507122 AO 5507123 AW		
123-4/72 	INKA-U123-4 5506310 AN 5506319 AO 5506318 AW	FCA-F80 5580080 AN 5580089 AO 5580060 WN 5580069 WR 5580088 AW	INKA-IH123-4 5506610 AN 5506612 AO				

AN= Aluminium, Natural anodized
 AO= Aluminium, Optional powder coated
 WN= Aluminium, White powder coated
 AW= White RAL 9016
 WR= White RAL
 GR= Grey

← = Left hand
 → = Right hand
 ↑ = Up, riser
 ↓ = Down, dropper



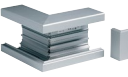

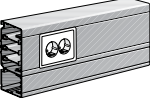
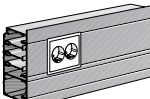
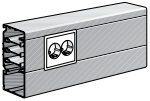
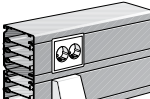
						
T-piece	Stop end	Joint cover	Wall collar	Cable shelf	Cable clip	Joining piece
INKA-TSU152 5575280 AN ↑ 5575284 AW	INKA-ES152 5591050 GR 5591052 AO 5591054 AW	TTI-US100 5590000 AN 5590002 AW	TTI-R2 100 5590720 WN TTI-CR100 5594511 WN	TTI-KH42 5590310 TTI-KH252 5590322	TTI-KL52 5590346	INKA-SSA 5590112
INKA-TSU101 5504140 AN ↑	INKA-ES101 5504170 GR 5504172 AO 5504173 AW INKA-ES101 5504160 WN 5504161 GR	TTI-US101 5590030 AN 5590032 AO 5590033 AW	TTI-R2 101 5590730 WN	TTI-KH72 5590312 5590314 TTI-KH272 5590319	TTI-KHK 5590340	INKA-SSA 5590112
INKA-TS123 5507140 AN 5507142 AO 5507143 AW	INKA-ES123 5507170 GR 5507172 AO 5507173 AW INKA-ES123 5507160 WN 5507161 GR	TTI-US123 5590035 AN 5590039 AO 5590036 AW 5590041 AW	TTI-CR 123 5594576 WN TTI-R2, R3 5590740 WN	TTI-KH72 5590312 5590314 TTI-KH272 5590319	TTI-KHK 5590340	INKA-SSA 5590112
	INKA-ESV123-4 5590200 GR 5590203 AO ← 5590204 WN ← INKA-ESH123-4 5590205 GR → 5590208 AO → 5590209 AW →			TTI-KH72 5590312 5590314 TTI-KH272 5590319	TTI-KHK 5590340	INKA-SSA 5590112

Product Range, type INKA





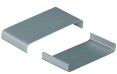
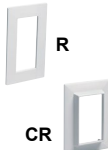

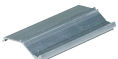



In the matrix: Type Art. No. Material/Finish	 P61444	 P61884	 P61883	 P61439	 P61433	 P61391	
INKA-	Trunking base	Front cover	Front cover	Internal corner	External corner	Bend, 90°	
161-2/72 	INKA-U161-2 5510010 AN 5510012 AO	FCA-F80 5580080 AN 5580089 AO 5580088 AW 5580060 WN 5580069 WR	FCA-F40 5580030 AN 5580039 AO 5580038 AW	INKA-IH161-2 5510200 AN 5510202 AO 5510203 AW	INKA-YH161-2 5510212 AO 5510210 AN 5510213 AW	INKA-LSU161-2 5510220 AN ↑ 5510222 AO ↑ 5510223 AW ↑ INKA-LSN161-2 5510230 AN ↓ 5510233 AW	
161-2F/72 	INKA-U161-2F 5512410 AN 5512418 AW	FCA-F80 5580080 AN 5580089 AO 5580088 AW 5580060 WN 5580069 WR	FCA-F40 5580030 AN 5580039 AO 5580038 AW				
161-3/72 	INKA-U161-3 5510020 AN 5510022 AO 5510023 AW	FCA-F80 5580080 AN 5580089 AO 5580088 AW 5580060 WN 5580069 WR		INKA-IH161-3 5510302 AO			
217-2/72 	INKA-U217-2 5514000 AN 5514002 AO 5514003 AW	FCA-F80 5580080 AN 5580089 AO 5580088 AW 5580060 WN 5580069 WR		INKA-IH217-2 5514100 AN 5514102 AO 5514103 AW	INKA-YH217-2 5514110 AN		

AN= Aluminium, Natural anodized
 AO= Aluminium, Optional powder coated
 AW= Aluminium, White powder coated
 AW= White RAL 9016
 WR= White RAL 9010
 GR= Grey

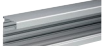

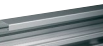







← = Left hand
 → = Right hand
 ↑ = Up, riser
 ↓ = Down, dropper

						
T-piece	Stop end	Joint cover	Wall collar	Cable shelf	Cable clip	Joining piece
INKA-TSU161-2 5510242 AO	INKA-ES161 5510170 AN 5510172 AO 5510173 AW INKA-ES161 5510160 WN 5510161 GR	TTI-US161-2 5590060 AN 5590069 AO 5590068 AW	TTI-R2 161 5590760 WN TTI-CR 161 5594615 WR 5594616 WN	TTI-KH72 5590312 5590314 TTI-KH272 5590319	TTI-KHK 5590340	INKA-SSA 5590112
	INKA-ESV161-2 5590260 AN ← 5590264 AW ← INKA-ESH161-2F 5590265 AN → 5590269 AW →			TTI-KH72 5590312 5590314 TTI-KH272 5590319	TTI-KHK 5590340	INKA-SSA 5590112
	INKA-ES161 5510170 AN 5510172 AO INKA-ES161 5510160 WN 5510161 GR	TTI-US161-3 5590070 AN 5590073 AO 5590075 AW	TTI-R2 161 5590760 WN TTI-CR 161 5594615 WR 5594616 WN	TTI-KH72 5590312 5590314 TTI-KH272 5590319	TTI-KHK 5590340	INKA-SSA 5590112
	INKA-ES217-2 5514170 AN 5514173 AW INKA-ES217 5514160 WN 5514161 GR	TTI-US217-2 5590090 AN 5590092 AO 5590093 AW	INKA-R2 217-2 5590770 WN	TTI-KH72 5590312 5590314 TTI-KH272 5590319	TTI-KHK 5590340	INKA-SSA 5590112

Trunking base

Type	Colour	Dimensions A/B/C (mm)		Qty per package	EAN code	Ref. No.	
Trunking base, one compartment							
Trunking base for wall surface mounting or on brackets. Can be divided into compartments by cable shelves. To be used together with a front cover. Intended mainly for installation at mid-wall (window-sill) or skirting level. Material: Aluminium.							
P61399		INKA-U101	Natural	101/72/2500	4	7315885504004	5504000
			Optional			7315880035091	5504002
			White RAL 9016			7315880036210	5504003
P61397		INKA-U123	Natural	123/72/2500	4	7315885507005	5507000
			Optional			7315880036456	5507002
			White RAL 9016			7315880036463	5507003
P61398		INKA-U152	Natural	100/52/2500	4	7315885519084	5519080
			Optional			7315880026013	5519082
			White RAL 9016			7315880048831	5519084
P61445		INKA-U161-3	Natural	161/72/2500	4	7315885510029	5510020
			Optional			7315880036708	5510022
			White RAL 9016			7315880036715	5510023
Same as above but in optional length, unit metre. Material: Aluminium.							
P61397		INKA-U123	Natural	123/72/ Optional	—	7315885507807	5507800
			Optional			7315880036616	5507802
P61398		INKA-U152	Natural	100/52/ Optional	—	7315885598126	5598120
Trunking base, two compartments							
Trunking base for wall surface mounting or on brackets. Divided into an upper and a lower compartment by an integrated partition wall, which is pre-punched every 200 mm. Can be divided into further compartments by cable shelves. To be used with 80 mm front cover. Intended mainly for installation at mid-wall (window-sill) or skirting level. Material: Aluminium.							
P61403		INKA-U161-2	Natural	161/72/2500	4	7315885510012	5510010
			Optional			7315880036678	5510012
			White RAL 9016			7315880036685	5510013
P61402		INKA-U217-2	Natural	217/72/2500	2	7315885514003	5514000
			Optional			7315880037316	5514002
			White RAL 9016			7315880037323	5514003
Trunking base with flange, one compartment							
Trunking base with flange for mounting flush with the wall. Can be divided into further compartments by cable shelves. Also suitable for use as feeder trunking. Material: Aluminium.							
P61401		INKA-U123-4	Natural	123/72/2500	4	7315885506312	5506310
			White RAL 9016			7315880005759	5506318
			Optional			7315880024569	5506319
Trunking base with flange, two compartments							
Trunking base with flange for mounting flush with the wall. Divided into an upper and a lower compartment by an integrated partition wall, which is pre-punched every 200 mm. Can be divided into further compartments by cable shelves. Also suitable for use as feeder trunking. Material: Aluminium.							
P61400		INKA-U161-2F	Natural	161/72/2500	4	7315885512412	5512410
			White RAL 9016			7315880005865	5512418

Corner sections

Type	Colour	Dimensions A/B/C (mm)	Qty per package	EAN code	Ref. No.		
Internal corner							
Internal corner with 80 mm front opening. Can be divided into compartments by cable shelves. To be used together with front cover. Material: Aluminium.							
P61435		INKA-IH101	Natural	100/200/200*	1	7315885504103	5504100
			Optional			7315880036234	5504102
			White RAL 9016			7315880036241	5504103
P61439		INKA-IH123	Natural	123/200/200*	1	7315885507104	5507100
			Optional			7315880036487	5507102
			White RAL 9016			7315880036494	5507103
P61483		INKA-IH123-4	Natural	145/200/200*	1	7315885506619	5506610
			White RAL 9016			7315880061298	5506614
P61485		INKA-IH152	Natural	100/200/200*	1	7315885575257	5575250
			White RAL 9016			7315880050049	5575254
P61467		INKA-IH161-3	Optional	161/200/200*	1	7315880037040	5510302
Internal corner with 80 and 40 mm front openings. Divided into an upper and a lower compartment by an integrated partition wall. Can be divided into further compartments by cable shelves. To be used together with front cover. Material: Aluminium.							
P61431		INKA-IH161-2	Natural	161/200/200*	1	7315885510203	5510200
			Optional			7315880036869	5510202
			White RAL 9016			7315880036876	5510203
P61484		INKA-IH217-2	Natural	217/200/200*	1	7315885514102	5514100
			Optional			7315880037347	5514102
			White RAL 9016			7315880037354	5514103
Internal corner, adjustable, type TTI							
Open internal corner that covers the opening between two trunking lengths installed in an angle to one another. The corner section is made up by two parts which can be moved against one another to create the required angle. Angle adjustment 90–135°. Degree of protection: IP40, provided that the trunking system is mounted direct on the wall. For TTI-IH123, covering plate TTI-BP can be used to reach IP20 when the system is mounted on brackets. Material: PC/ABS.							
P63861		TTI-IH100	White RAL 9016	100/52/140	1	7315885589155	5589150
		TTI-IH123	White RAL 9016	123/72/145	1	7315885589179	5589170
External corner kit							
External corner kit with 80 mm front opening, including front cover. Can be divided into compartments by cable shelves. Material: Aluminium.							
P61438		INKA-YH101	Natural	100/200/200*	1	7315885504110	5504110
			Optional			7315880036265	5504112
			White RAL 9016			7315880036272	5504113
P61433		INKA-YH123	Natural	123/200/200*	1	7315885507111	5507110
			Optional			7315880036517	5507112
			White RAL 9016			7315880036524	5507113
P61436		INKA-YH152	Natural	100/200/200*	1	7315885575264	5575260
			White RAL 9016			7315880050056	5575264

* Wall-side measure.

Corner sections

Type	Colour	Dimensions A/B/C (mm)		Qty per package	EAN code	Ref. No.
External corner kit						
External corner kit with 80 and 40 mm front openings, including front covers. Divided into an upper and a lower compartment by an integrated partition wall. Can be divided into further compartments by cable shelves. Material: Aluminium.						
INKA-YH161-2	Natural	161/200/200*		1	7315885510210	5510210
	Optional				7315880036890	5510212
	White RAL 9016				7315880036906	5510213
INKA-YH217-2	Natural	217/200/200*		1	7315885514119	5514110
	White RAL 9016				7315880037385	5514113
External corner, adjustable, type TTI						
Open external corner that covers the opening between two trunking lengths installed in an angle to one another. The corner section is made up by two parts which can be moved against one another to create the required angle. Angle adjustment 85–135°. Degree of protection: IP40, provided that the trunking system is mounted direct on the wall. For TTY-IH123, covering plate TTI-BP can be used to reach IP20 when the system is mounted on brackets. Material: PC/ABS.						
TTI-YH100	White RAL 9016	100/52/110		1	7315885589506	5589500
TTI-YH123	White RAL 9016	123/72/145		1	7315885589520	5589520

Bends

Bend, 90°, kit						
90° bend with 80 mm front opening. Kit including 225 mm front cover. Can be divided into compartments by cable shelves. Some sizes available as a riser or a dropper. Material: Aluminium.						
INKA-LSN101 Dropper	White RAL 9016	200/72/200		1	7315880036333	5504133
	White RAL 9016					
INKA-LSU101 Riser	White RAL 9016	200/72/200		1	7315880036548	5507120
INKA-LS123	Natural	200/72/200		1	7315885507128	5507120
	Optional				7315880036548	5507122
	White RAL 9016				7315880036555	5507123
INKA-LSU152 Riser	Natural	200/52/200		1	7315885575271	5575270
	White RAL 9016				7315880050063	5575274
90° bend with 80 and 40 mm front openings. Kit including 225 mm front cover. Divided into an upper and a lower compartment by an integrated partition wall. Can be divided into further compartments by cable shelves. Available as a riser or a dropper. Material: Aluminium.						
INKA-LSN161-2 Dropper	Natural	200/72/200		1	7315885510234	5510230
	White RAL 9016				7315880036968	5510233
INKA-LSU161-2 Riser	Natural	200/72/200		1	7315885510227	5510220
	Optional				7315880036920	5510222
	White RAL 9016				7315880036937	5510223



Bends

Type	Colour	Dimensions A/B/C (mm)	Qty per package	EAN code	Ref. No.
T-piece, kit					
T-piece with 80 mm front opening. Kit including 225 mm front cover. Can be divided into compartments by cable shelves. Some sizes available as a riser. Material: Aluminium.					
INKA-TSU101 Riser	Natural	200/72/200	1	7315885504141	5504140
INKA-TS123	Natural	200/72/200	1	7315885507142	5507140
	Optional			7315880036579	5507142
	White RAL 9016			7315880036586	5507143
INKA-TSU152 Riser	Natural White RAL 9016	200/52/200	1	7315885575288 7315880050070	5575280 5575284
T-piece with 80 and 40 mm front openings. Kit including 225 mm front covers. Divided into an upper and a lower compartment by an integrated partition wall. Can be divided into further compartments by cable shelves. Available as a riser. Material: Aluminium.					
INKA-TSU161-2 Riser	Optional	260/72/360	1	7315880036982	5510242





Stop ends

Stop end					
Stop end intended to cover the ends of the trunking base. Available as left-hand and right-hand type for INKA-123-4. Material: ABS or Aluminium, powder-coated or natural anodized.					
INKA-ES101 ABS	Grey	103/33/75	1	7315880035107	5504161
	White RAL 9016			7315885504165	5504160
INKA-ES101 Aluminium	Alu metallic	100/26/72	1	7315885504172	5504170
	Optional			7315880044635	5504172
	White RAL 9016			7315880044642	5504173
INKA-ES123 ABS	Grey	123/-/75	1	7315880035114	5507161
	White RAL 9016			7315885507166	5507160
INKA-ES123 Aluminium	Optional	123/27/72	1	7315880044666	5507172
	Alu metallic			7315885507173	5507170
	White RAL 9016			7315880044673	5507173
INKA-ESH123-4 Aluminium, right	Optional	145/72	1	7315880034490	5590208
	Natural			7315880034476	5590205
	White RAL 9016			7315880061304	5590209
INKA-ESV123-4 Aluminium, left	Optional	145/72	1	7315880034469	5590203
	Natural			7315880034445	5590200
	White RAL 9016			7315885590205	5590204
INKA-ES152 Aluminium	Natural	100/52/2	1	7315885591059	5591050
	Optional			7315880026594	5591052
	White RAL 9016			7315880051671	5591054
INKA-ES161 ABS	Grey	165/75/-	1	7315880035121	5510161
	White RAL 9016			7315885510166	5510160
INKA-ES161 Aluminium	Natural	161/72/28	1	7315885510173	5510170
	Optional			7315880044741	5510172
	White RAL 9016			7315880044758	5510173
INKA-ES217-2 ABS	Grey	220/-/75	1	7315880035138	5514161
	White RAL 9016			7315885514164	5514160
INKA-ES217-2 Aluminium	Natural	217/28/72	1	7315885514171	5514170
	White RAL 9016			7315880044789	5514173





Stop ends

Type	Colour	Dimensions A/B/C (mm)	Qty per package	EAN code	Ref. No.	
Stop end						
Stop end intended to cover the ends of the trunking base. With flange for flush mounting. Material: Aluminium, powder-coated or natural anodized.						
P61505 	INKA-ESV161-2F Left-hand	Natural White RAL 9016	185/72/33	1	7315885590267 7315880057369	5590260 5590264
	INKA-ESH161-2F Right-hand	Natural White RAL 9016	185/72/33	1	7315880031925 7315880057376	5590265 5590269
Bracket for stop end						
Bracket for extra strong fixing of ABS stop ends for INKA. Suitable for INKA-ES101, -ES161 and -ES217-2. Material: Sheet steel.						
P61750 	TTI-FE	—	35/34/18	1	7315885590199	5590190

Front covers type FCA

Aluminium Front covers							
Front cover for service carriers with 40 and 80 mm front opening respectively. Material: Aluminium, natural anodized or powder coated.							
P61883 	FCA-F40	Natural anodized White RAL 9016 Optional	40/13/2500	8	7315885580039 7315880006817 7315880006824	5580030 5580038 5580039	
	P61884 	FCA-F80	Natural anodized White RAL 9016 Optional	80/13/2500	8	7315885580084 7315880006930 7315880006947	5580080 5580088 5580089
		PVC Front covers					
Front cover for service carriers with 80 mm front opening. Material: PVC.							
P61885 	FCA-F80	White RAL 9016 White RAL 9010	80/13/2500	8	7315885580060 7315880006909	5580060 5580069	
Front cover brace							
Front cover brace for front covers F40 and F80 respectively. Used to maintain correct front cover retention in cases of heavy cable loads. Material: Steel, electroplated.							
P61521 	FCA-B80	—	10/14/81	10	7315885580916	5580900	





Wall brackets with accessories type TTA

Adjustable wall brackets						
Adjustable wall bracket for wall-mounting of trunking. Suitable for use together with ventilation-rib holder kit TTA-GH1 or rib holder TTA-GH6. Material: Steel, unpainted/Aluminium.						
P61680 	TTA-TN50	Adjustable 50–70	121/67/50	10	7315885583573	5583570
	TTA-TN70	Adjustable 70–110	121/67/70	10	7315880095118	5583572
	TTA-TN110	Adjustable 110–170	121/67/110	10	7315880095125	5583574
	TTA-TN160	Adjustable 160–260	180/67/160	10	7315880095132	5583576
P111360 	Adjustable wall bracket including loose plastic rib holder TTA-GH1 with steel clamp, for wall-mounting of trunking. The loose rib holder is suitable for ventilation ribs TTA-G10 and TTA-G3. Material: Steel, unpainted, PC/ABS.					
	TTA-KVS60A	Adjustable 30–60	77/30/28	10	7315885583603	5583608
Fixed wall bracket						
Fixed wall bracket for wall-mounting of trunking. Material: Aluminium, untreated.						
P193216 	TTA-KV15	—	113/23/28	10	7315885583016	5583010
P193217 	TTA-KV35	—	130/43/28	10	7315880010241	5583014







Wall brackets with accessories type TTA

Type	Colour	Dimensions A/B/C (mm)	Qty per package	EAN code	Ref. No.
Fixed wall bracket with integrated rib holder					
Fixed wall bracket with integrated rib holder, for wall-mounting of trunking. The integrated rib holder is suitable for ventilation rib TTA-G10. Material: Aluminium, untreated.					
TTA-KV35-1	—	130/43/28	10	7315880010258	5583016
TTA-KV56-2	—	130/64/28	10	7315880010265	5583018
TTA-KV79-3	—	130/86/28	10	7315885583023	5583020
TTA-KV101-4	—	132/109/28	10	7315880010272	5583022
TTA-KV123-5	—	132/131/28	10	7315880010289	5583024
TTA-KV146-6	—	130/153/28	10	7315880010296	5583026
Fixed wall bracket with loose rib holder					
Fixed wall bracket including loose plastic rib holder TTA-GH1 with steel clamp, for wall-mounting of trunking. The loose rib holder is suitable for ventilation ribs TTA-G10 and TTA-G3. Material: Aluminium, untreated, PC/ABS.					
TTA-KV35	—	132/43/28	10	7315885583030	5583034
TTA-KV56	—	132/64/28	10	7315880029915	5583036
TTA-KV79	—	132/86/28	10	7315880029922	5583038
TTA-KV101	—	132/109/28	10	7315885583047	5583040
TTA-KV123	—	132/131/28	10	7315880029939	5583042
TTA-KV146	—	132/153/28	10	7315880029946	5583044
Ventilation-rib holder					
Rib holder to fix ventilation ribs G3 and G10 on the wall brackets. Suitable for TTA-TN, TTA-KV and TTA-KVS. Material: PC/ABS.					
TTA-GH6	Grey	15/120/34	10	7315880030034	5590453
Ventilation-rib holder, kit					
Kit including 10 plastic rib holders and 10 steel clamps, to be used to fix ventilation ribs G3 and G10 on the wall brackets. Suitable for TTA-TN, TTA-KV and TTA-KVS. Material: PC/ABS (rib holder), steel (clamp).					
TTA-GH1	Grey	15/120/34	1	7315880079873	5590456
Ventilation rib					
Ventilation rib to be used together with wall bracket for trunking and ventilation-rib holder. Material: Aluminium, natural anodized or powder coated.					
TTA-G3	Anodized White RAL 9016 White RAL 9010 Optional	20/3/2500	40	7315885590489 7315880028949 7315880031987 7315880032533	5590480 5590481 5590482 5590483
TTA-G10	White RAL 9010 Anodized White RAL 9016 Optional	20/10/2500	16	7315880031956 7315885590434 7315880011842 7315880011903	5590424 5590430 5590431 5590439
Jointing piece					
Jointing piece to be used for jointing of ventilation ribs. Material: Aluminium, untreated.					
TTA-GS3	—	9/6/30	10	7315880028956	5590486
TTA-GS10	—	13/10/100	8	7315885590441	5590440
Washer					
Washer to be used between bracket and wall or trunking and wall, to compensate for uneven walls. Material: PP.					
TTA-KM3	Grey	114/3/38	10	7315885583405	5583408
TTA-KM5	Grey	114/5/38	10	7315885583412	5583410

Cable shelves type TTI

Type	Colour	Dimensions A/B/C (mm)	Qty per package	EAN code	Ref. No.	
Single cable shelf						
Single cable shelf to be used to divide the trunking into compartments, for the separation of cables. Material: PVC or aluminium, see below.						
P61423 	TTI-KH52	White PVC	10/46/500	50	7315885590311	5590310
	For 52 mm deep trunking					
P61405 	TTI-KH72	Anodized aluminium White PVC	12/62/500	50 50	7315880011576 7315880011583	5590312 5590314
	For 72 mm deep trunking					
Double cable shelf						
Double cable shelf to be used to divide the trunking into compartments, for the separation of cables. Material: PVC or PC/ABS, see below.						
P62067 	TTI-KH252	White PVC	58/46/500	20	7315885590328	5590322
	For 52 mm deep trunking					
P61404 	TTI-KH272	White PVC	64/59/500	20	7315880071341	5590319
	For 72 mm deep trunking					
	TTI-KH272C	White PC/ABS	64/59/500	20	7315880089377	5590311
For 72 mm deep trunking						
Cable clip						
Cable clip to be snap-fitted onto the cable shelf, used to retain the cables in their place. Material: PA (TTI-KL52), ABS (TTI-KHK).						
P61936 P61514 	TTI-KL52	Black	13/25/40	50	7315880011644	5590346
	For TTI-KH252					
TTI-KHK						
Brown						
6/43/34						
100						
7315885590342						
5590340						

Joint cover pieces type TTI

Joint cover piece, kit						
Joint cover kits including two or three joint cover pieces to cover joints between trunking sections. Material: Aluminium, untreated, anodized or powder coated.						
P61735 	TTI-US100	Natural White RAL 9016	—/45/52	1 pair	7315885590007 7315880037699	5590000 5590002
	For 52 mm deep trunking					
P61747 	TTI-US101	Natural White RAL 9016 Optional	—/45/72	1 pair	7315885590038 7315880027942 7315880026495	5590030 5590033 5590032
	For 72 mm deep trunking					
	Optional					
P61748 	TTI-US123	Natural White RAL 9016 Optional	—/45/72	1 pair	7315880010982 7315880010999 7315880011026	5590035 5590036 5590039
	For 72 mm deep trunking					
	Optional					
P61740 	TTI-US161-2	Natural White RAL 9016 Optional	—/45/72	1 pair	7315885590069 7315880011071 7315880011088	5590060 5590068 5590069
	For 72 mm deep trunking					
	Optional					
P61743 	TTI-US161-3	Natural White RAL 9016 Optional	—/45/72	1 pair	7315885590076 7315880046080 7315880022022	5590070 5590075 5590073
	For 72 mm deep trunking					
	Optional					
P61744 	TTI-US217-2	Natural White RAL 9016 Optional	—/45/72	1 pair	7315885590090 7315880011118 7315880023852	5590090 5590093 5590092
	For 72 mm deep trunking					
	Optional					

Wall frames/collars type INKA and TTI

Type	Colour	Dimensions A/B/C (mm)		Qty per package	EAN code	Ref. No.
Wall frame						
Wall frame made up by two parts which are assembled and mounted on the trunking by means of two rubber mouldings. The frame has a flange against the trunking. To be used to cover a trunking passage through the wall or to make an attractive finish of the trunking against a wall. Material: ABS.						
TTI-CR100 For 100x52 mm trunking	White RAL 9016	170/25/120		1	7315885594517	5594511
TTI-CR123 For 123x72 mm trunking	White RAL 9016	193/25/140		1	7315880066637	5594576
TTI-CR161 For 161x72 mm trunking	White RAL 9016 White RAL 9010	231/25/140		1	7315880066644 7315885594616	5594616 5594615
Wall collar INKA						
Wall collar to be used to cover a trunking passage through the wall or to make an attractive finish of the trunking against a wall. Material: ABS.						
INKA-R2 For 123	White RAL 9016	253/8/142		1	7315885590755	5590750
INKA-R2 For 217-2	White RAL 9016	284/8/142		1	7315885590779	5590770
Wall collar TTI						
Wall collar made up by two parts that are snapped together. To be used to cover a trunking passage through the wall or to make an attractive finish of the trunking against a wall. Material: ABS.						
TTI-R2 100 For 152	White RAL 9010	161/2.5/103		1	7315880028048	5590720
TTI-R2 101 For 101	White RAL 9016	176/8/107		1	7315885590731	5590730
TTI-R2 123 For 123	White RAL 9016	199/8/142		1	7315885590748	5590740
TTI-R2 161 For 161-2, 161-3	White RAL 9016	238/8/142		1	7315885590762	5590760
Other accessories type INKA and TTI						
Joining pieces						
Clamp for jointing and earthing of the trunking base. To be mounted in the jointing slot of the trunking. Material: Aluminium.						
INKA-SSA	Natural	8/32/60		20	7315880011200	5590112
INKA-SSJ Including screws	Natural	8/32/60		20	7315885590113	5590110
Mounting washer						
Mounting washer provided with screw hole for mounting to the wall by means of a countersunk screw. The mounting washers are to be placed on the wall along a chalk lining. The trunking is then easily hung on the mounting washers and screw-fixed directly to the wall. Suitable for INKA-123, 161-2, 161-3 and 217-2. Material: PA, injection moulded.						
TTI-MB	Black	5/15/19		100	7315885590182	5590180
Cup washer						
Cup washer to cover screw heads inside the trunking in order to protect single-insulated cables. Material: PE.						
TTI-KB	Black	Ø13		100	7315885590526	5590520

P61428



P61429



P61429



P61624



P61429



P61752



P138340



P61881



P61937



Other accessories type INKA and TTI

Type	Colour	Dimensions A/B/C (mm)		Qty per package	EAN code	Ref. No.
Earthing clamps						
Earthing clamp for aluminium trunking and accessories. To be turned into the earthing slot of the trunking. Intended for an area of max. 4 mm ² . Material: Steel, zinc coated.						
TTI-JB	—	18/12/22		10	7315885590502	5590500
Earth wires						
Earth wire including cable clip, to be used to bond the front cover to the trunking base. The cable clip has an extra connection for an additional cable clip. Material: Copper (conductor).						
TTI-JKE300	Yellow green	Length 300		10	7332418015530	5590513
Sound insulation strips						
Sound insulation strip to be used for sound absorbing up to 53 dB when a trunking passes through a wall. Supplied in a set of four for up to four compartments. Material: Foam plastic.						
TTI-T3045	Black	30/45/350		1	7315885590410	5590410
TTI-T5070	Black	50/70/350		1	7315880011828	5590414

PR1887



PR3575



PR1537



INKA aluminium trunking

Technical description

Technical data

Standards and certificates	The products comply with the standard EN50085-1 The products satisfy the provisions for CE marking according to the Low Voltage Directive 73/23/EEC and 93/68/EEC. The products comply with the RoHS directive 2002/95/EC (Restriction of Hazardous Substances)
----------------------------	---

Material data INKA

Material	Aluminium, SS:4104, DIN Al Mg Si 0,5, BS:H9
Surface treatment	Natural anodizing or powder coating
Colour spec.	<ul style="list-style-type: none"> • White RAL 9010 • White RAL 9016 • Alu metallic • Optional acc. to customer choice (use the Ref. No. and add the desired RAL colour and gloss).

Material data FCA

Material	Extruded aluminium
Surface treatment	Natural anodizing or powder coating
Colour spec.	<ul style="list-style-type: none"> • White RAL 9016 • White RAL 9010 • Optional acc. to customer choice (use the Ref. No. and add the desired RAL colour and gloss).
Material	PVC (self-extinguishing, lead and cadmium-free)
Fire rating	UL 94 V0 (0.8 mm)
Colour spec.	<ul style="list-style-type: none"> • White RAL 9010 • White RAL 9016

Material data TTA

Material	Steel
Surface treatment	Galvanized
Colour spec.	Unpainted
Material	Aluminium SS 4104
Colour spec.	<ul style="list-style-type: none"> • Unpainted • White RAL 9010 • White RAL 9016 • Optional acc. to customer choice (use the Ref. No. and add the desired RAL colour and gloss).
Material	PC/ABS (polycarbonate/acrylonitrile-butadiene-styrene)
Colour	Grey
Material	PP (polypropylene)
Colour	Grey

Material data TTI

Material	PC/ABS (polycarbonate/acrylonitrile-butadiene-styrene)
Fire rating	UL 94 V0
Impact resistance	2 J (medium acc. to EN 50085-1)
Colour spec.	<ul style="list-style-type: none"> • White RAL 9010 • White RAL 9016 • Light grey (aluminium metallic)
Material	ABS (acrylonitrile-butadiene-styrene)
Colour spec.	<ul style="list-style-type: none"> • White RAL 9016 • White RAL 9010 • Brown NCS 8203-Y63R

Material data TTI, cont.

Material	PVC (self-extinguishing, lead and cadmium-free)
Colour	White, unspecified
Material	PE (polyethylene, halogen-free)
Fire rating	UL 94 HB
Chemical resistance	Resistant to lubricants, fuel, refrigerants, enamels and paints, detergents and degreasing agents. Not resistant to acids.
Colours	<ul style="list-style-type: none"> • White • Black
Material	PA (polyamide)
Fire rating	UL 94 V-0
Colour	Black
Material	Stainless steel SS
Linear expansion	$16.5 \times 10^{-6} / ^\circ\text{C}$
Material	Aluminium SS 4106
Surface treatment	Natural anodizing 5–10 µm or powder coating
Colour spec.	<ul style="list-style-type: none"> • White RAL 9010 • White RAL 9016 • Optional acc. to customer choice (use the Ref. No. and add the desired RAL colour and gloss).

Operative data

Temperature range	From –20°C to +60°C
Suitable outdoors	No
Degree of protection	IP20

Mounting instructions

Art.No. 0055000 / 20041392	INKA-101, INKA-152
Art.No. 0055002 / 20041393	INKA-123, INKA-161-2 & -3, INKA-217-2
Art.No. 0055001 / 20041394	INKA-123-4, INKA-161-2F
Art.No. 0055117 / 20072390	TTA-KVS60A adjustable wall bracket
Art.No. 0075142 / 20045813	TTI-KH cable shelf
Art.No. 0075340 / 20041386	TTI-IH int. corner, adjustable
Art.No. 0075341 / 20041387	TTI-YH ext. corner, adjustable

Mounting instructions are always included with the length material (trunking INKA) or with the accessories (TTA, TTI).

INKA-152/52
For wall surface mounting.

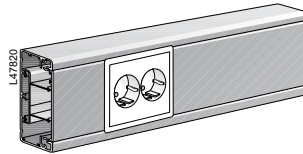
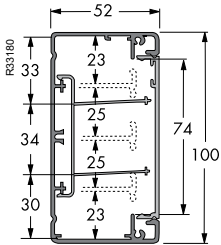

INKA-101/72
For wall surface mounting.

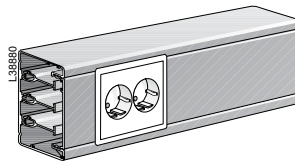
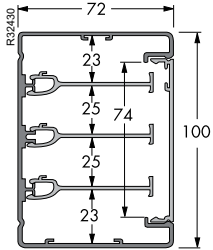

INKA-123/72
For wall surface mounting or on brackets.

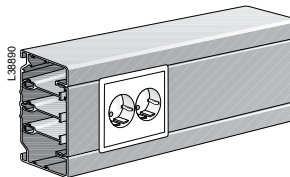
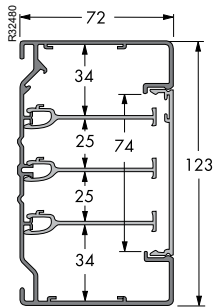

INKA-123-4/72
For flush mounting.

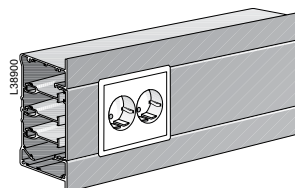
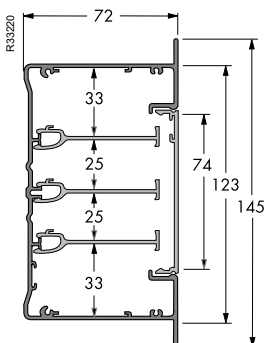

INKA aluminium trunking

Design and dimensions

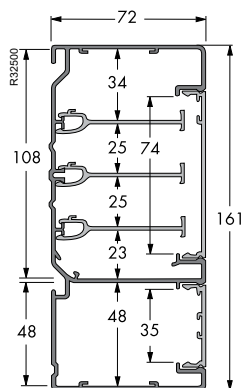

INKA-161-2/72

For wall surface mounting or on brackets. Two screened compartments with separate front covers.

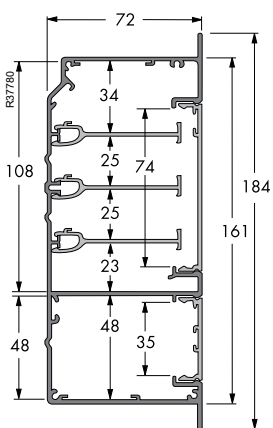
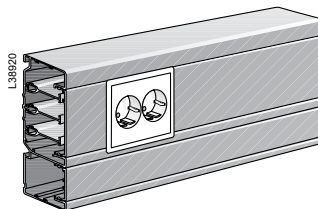

INKA-161-2F/72

For flush mounting. Two screened compartments with separate front covers.

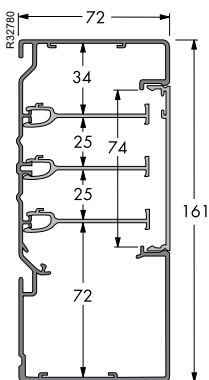
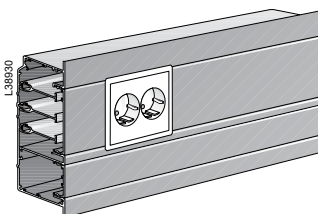

INKA-161-3/72

For wall surface mounting or on brackets.

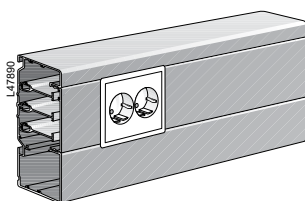

INKA aluminium trunking

Design and dimensions

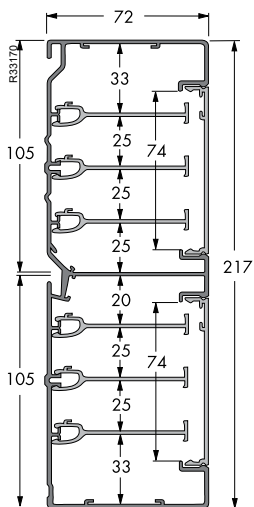

INKA-217-2/72

For wall surface mounting or on brackets. Two screened compartments with separate front covers.

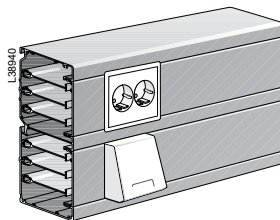

Exploded view

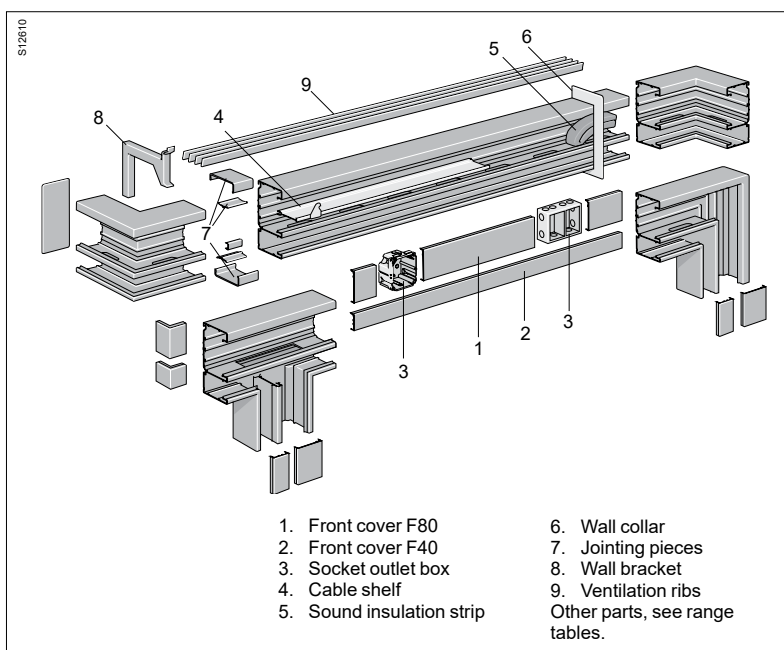

Cable capacity

INKA-152/52

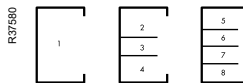

Without mounting boxes

1	35	3429	1372	1715	2057
2	25	1007	403	504	604
3	25	902	361	451	541
4	25	968	387	484	581
5	15	702	281	351	421
6	20	759	304	380	455
7	20	759	304	380	455
8	25	809	324	405	485

With 40 mm deep MIB & CYB boxes

1	12	1162	465	581	697
2	12	439	176	220	263
3	0	0	0	0	0
4	12	434	174	217	260
5	12	445	178	223	267
6	6	86	34	43	52
7	6	87	35	44	52
8	12	435	174	218	261

With 30 mm deep CYB boxes

1	12	1287	515	644	772
2	12	423	169	212	254
3	0	0	0	0	0
4	12	449	180	225	269
5	12	415	166	208	249
6	8	119	48	60	71
7	8	125	50	63	75
8	12	452	181	226	271

Cable capacity INKA-101/72

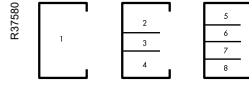

Comp No	Max Ø mm	Cross section area mm ²	Cable capacity, mm ²		
			40%	50%	60%
Without mounting boxes					
1	60	5565	2226	2783	3339
2	30	1316	526	658	790
3	30	1197	479	599	718
4	25	1313	525	657	788
5	20	1303	521	652	782
6	20	1199	480	600	719
7	20	1199	480	600	719
8	20	1308	523	654	785
With 40 mm deep MIB & CYB boxes					
1	20	3334	1333	1667	2000
2	15	956	382	478	574
3	15	495	498	248	297
4	20	926	370	463	556
5	15	977	391	489	586
6	15	476	190	238	286
7	15	476	190	238	286
8	20	974	390	487	584
With 30 mm deep CYB boxes					
1	20	3580	1432	1790	2148
2	20	982	393	491	589
3	15	576	230	288	346
4	20	954	382	477	572
5	15	1037	415	519	622
6	15	522	209	261	313
7	15	522	209	261	313
8	20	1025	410	513	615

Cable capacity INKA-123-4/72

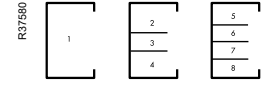

Comp No	Max Ø mm	Cross section area mm ²	Cable capacity, mm ²		
			40%	50%	60%
Without mounting boxes					
1	60	6857	2743	3429	4114
2	40	1801	720	901	1081
3	30	1197	479	599	718
4	35	1734	694	867	1040
5	30	1865	746	933	1119
6	20	1199	480	600	719
7	20	1199	480	600	719
8	30	2089	836	1045	1253
With 40 mm deep MIB & CYB boxes					
1	25	4597	1839	2299	2758
2	25	1405	562	703	843
3	15	495	198	248	297
4	20	1349	540	675	809
5	25	1634	654	817	980
6	15	476	190	238	286
7	15	476	190	238	286
8	20	1641	656	821	985
With 30 mm deep CYB boxes					
1	25	4706	1882	2353	2824
2	25	1403	561	702	842
3	15	576	230	288	346
4	20	1375	550	688	825
5	25	1597	639	799	958
6	15	522	209	261	313
7	15	522	209	261	313
8	20	1669	668	835	1001

INKA-123/72

Without mounting boxes					
1	60	6301	2520	3151	3781
2	35	1676	670	838	1006
3	30	1197	479	599	718
4	30	1700	680	850	1020
5	30	1812	765	956	1147
6	20	1199	480	600	719
7	20	1199	480	600	719
8	25	1709	684	855	1025
With 40 mm deep MIB & CYB boxes					
1	20	4523	1809	2262	2714
2	20	1318	527	659	791
3	15	495	198	248	297
4	20	1317	527	659	790
5	20	1575	630	788	945
6	15	476	190	238	286
7	15	476	190	238	286
8	20	1602	641	801	961
With 30 mm deep CYB boxes					
1	20	4786	1914	2393	2872
2	20	1347	539	674	808
3	15	576	230	288	346
4	20	1343	537	672	806
5	20	1637	655	819	982
6	15	522	209	261	313
7	15	522	209	261	313
8	20	1664	666	832	998

Cable capacity INKA-161-2/72

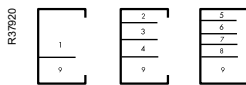

Comp No	Max Ø mm	Cross section area mm²	Cable capacity, mm²		
			40%	50%	60%
Without mounting boxes					
1	60	6101	2440	3051	3661
2	35	167	67	84	100
3	30	1197	479	599	718
4	25	1253	501	627	752
5	30	1925	770	963	1155
6	20	1199	480	600	719
7	20	1199	480	600	719
8	25	1273	509	637	764
9	30	2740	1096	1370	1644

With 40 mm deep MIB & CYB boxes

1	20	3869	1548	1935	2321
2	20	1343	537	672	806
3	15	495	198	248	297
4	20	878	357	439	527
5	20	1591	636	796	955
6	15	476	190	238	286
7	15	476	190	238	286
8	20	940	376	470	564
9	30	2740	1096	1370	1644

With 30 mm deep CYB boxes

1	20	3914	1566	1957	2348
2	20	1366	546	683	820
3	15	576	230	288	346
4	20	1007	403	504	604
5	20	1651	660	826	991
6	15	522	209	261	313
7	15	522	209	261	313
8	20	1001	400	501	601
9	30	2740	1096	1370	1644

Cable capacity INKA-161-2F/72

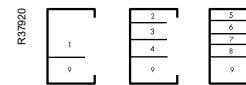

Comp No	Max Ø mm	Cross section area mm²	Cable capacity, mm²		
			40%	50%	60%
Without mounting boxes					
1	60	6069	2428	3035	3641
2	40	1687	675	844	1012
3	30	1197	479	599	718
4	30	1296	518	649	778
5	30	1728	691	864	1037
6	20	1199	480	600	719
7	20	1199	480	600	719
8	25	1438	575	719	863
9	30	2706	1082	1353	1624

With 40 mm deep MIB & CYB boxes

1	20	3089	1236	1545	1853
2	25	1285	514	643	771
3	15	495	198	248	297
4	20	911	364	456	547
5	25	1495	598	748	897
6	15	476	190	238	286
7	15	476	190	238	286
8	20	984	394	492	590
9	30	2706	1082	1353	1624

With 30 mm deep CYB boxes

1	20	3919	1568	1960	2351
2	20	1292	517	646	775
3	15	576	230	288	346
4	20	916	366	458	550
5	20	1470	588	735	882
6	15	522	209	261	313
7	15	522	209	261	313
8	20	1017	407	509	610
9	30	2706	1082	1353	1624

INKA-161-3/72



Without mounting boxes					
1	60	9369	3748	4685	5621
2	35	1689	676	845	1013
3	30	1197	479	599	718
4	40	4808	1923	2404	2885
5	30	1909	764	955	1145
6	20	1199	480	600	719
7	25	1199	480	600	719
8	40	4556	1822	2278	2734

With 40 mm deep MIB & CYB boxes

1	20	7137	2855	3569	4282
2	20	1332	533	666	799
3	15	495	198	248	297
4	40	4346	1738	2175	2608
5	20	1573	629	833	944
6	15	476	190	238	286
7	15	476	190	238	286
8	40	4225	1690	2113	2535

With 30 mm deep CYB boxes

1	20	7372	2949	3686	4423
2	20	1357	543	679	814
3	15	576	230	288	346
4	40	4354	1742	2177	2612
5	20	1620	648	810	972
6	15	522	209	261	313
7	15	522	209	261	313
8	40	4273	1709	2137	2564

INKA-217-2/72

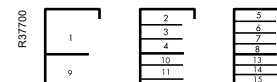

Without mounting boxes					
1	60	5962	2385	2981	3577
2	35	1685	674	843	1011
3	30	1197	479	599	718
4	25	1170	468	585	702
5	30	1905	762	953	1143
6-7	20	1199	480	600	719
8	20	1130	452	565	678
9	60	6010	2404	3005	3606
10	25	1131	452	566	679
11	30	1197	479	599	718
12	30	1766	706	883	1060
13	15	1082	433	541	649
14-15	20	1199	480	600	719
16	25	1985	794	993	1191

With 40 mm deep MIB & CYB boxes

1	20	3730	1492	1865	2238
2	20	1326	530	663	796
3	15	495	198	248	297
4	20	794	318	397	476
5	20	1653	661	827	992
6-7	15	476	190	238	286
8	20	797	319	399	478
9	20	3779	1512	1890	2267
10	15	785	314	393	471
11	15	495	198	248	297
12	20	1383	553	692	830
13	15	758	303	379	455
14-15	15	476	190	238	286
16	25	1651	660	826	991

With 30 mm deep CYB boxes

1	20	3980	1592	1990	2388
2	20	1353	541	677	812
3	15	495	198	248	297
4	20	819	328	410	491
5	20	1614	646	807	968
6-7	15	476	190	238	286
8	20	843	337	422	506
9	20	4014	1606	2007	2408
10	15	812	325	406	487
11	15	495	198	248	297
12	25	1409	564	705	845
13	15	807	323	404	484
14-15	15	476	190	238	286
16	25	1699	680	850	1019



DFK aluminium trunking with openable top Superior access for continuous updates and changing needs

With smooth design and securely concealed functions that provide easy cleaning, DFK aluminium trunking is the preferred choice in environments with the toughest hygiene requirements.



Always great access
Network cables placed in the upper compartment, enable excellent conditions for easy adjustments and additions.

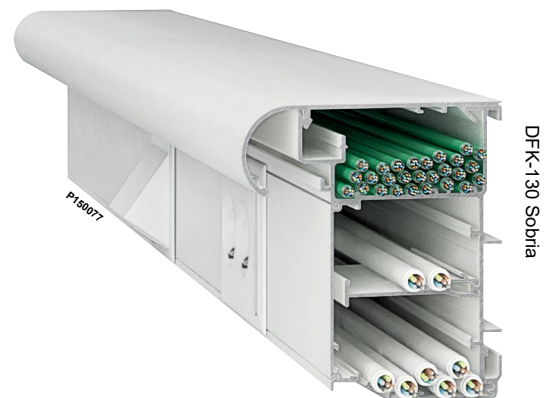

DFK – when hygiene is part of the operation

Smooth surface and a minimum number of joints ensure easy maintenance and spotlessly clean, hygienic installations in the most demanding environments.



Easy mounting



The setup of DFK differs from most installation trunking, allowing for instance easy joining of a feeder trunking.



Just add network

Thanks to top feeding, plenty of space and outstanding access, the DFK is ideal for continuous additions of network cables.





Length material

Type	Colour	Dimensions A/B/C (mm)	Qty per package	EAN code	Ref. No.
Trunking base					
Multi-compartment trunking base. To be assembled with contour profiles P90 and front cover F80 after the electric installation. Material: Aluminium, natural anodized or powder coated white.					
P139341 	White RAL 9016	133/95/2500	2	3606480630729	5501052
Contour profile					
Contour profile to be snapped into the trunking base. Provided with earthing slot. Available in two different shapes. Suitable for DFK-U130. Material: Aluminium, natural anodized or powder coated white.					
P149482 	White RAL 9016	40/119/2500	10	3606480630767	5582716

Form pieces

Internal corner					
Internal corner for DFK-U130. Material: Aluminium, natural anodized or powder coated white.					
P139344 	White RAL 9016	133/300/300 ¹⁾	1	3606480630736	5501602
¹⁾ Dimension of wall side.					

Other accessories

Stop end for trunking base					
Stop end to be snap-fitted to the trunking base from the side. Suitable for DFK-P90B and DFK-P90F respectively. Material: Sheet steel, powder coated.					
P149575 	White RAL 9016	135/119/50	1	7315885592087	5592080
P139667 	White RAL 9016	135/119/50	1	7315880066842	5592085
P139348 	Alu metallic	135/102/50	1	7315880112808	5592118
Wall collar					
Wall collar to be used where the trunking meets a wall. Material: PVC.					
P139349 	White	200/174/2	10	7315885592162	5592160
Joining piece					
Two joining pieces for the jointing of trunking bases or corners. To be mounted in the upper and lower compartment respectively. Material: PA.					
P139349 	White	15/55/100	10	7315885592018	5592010

Other accessories

Type	Colour	Dimensions A/B/C (mm)	Qty per package	EAN code	Ref. No.
Cable clip					
Cable clip to keep fibre optic cables in place. To be placed in the special fibre optic mini-duct in the top compartment. Material: PE.					
DFK-FC	Green	19/16/20	25	7315880035930	5592221
Cable clip to conceal cables under the contour profile. To be snap-fitted to the front edge of the trunking base. Material: PC/ABS.					
DFK-SC	Grey	11/22/20	10	7315880071358	5592222
Mounting washer					
Mounting washer to be used when the trunking is mounted directly onto the wall. The trunking base is placed on a number of mounting washers before being secured to the wall with screws. Material: PA.					
DFK-MB	Black	Ø13	25	7315885592216	5592210
Gauge piece					
Gauge piece for a neat appearance when joining two trunking base parts where cables are fed into the trunking. Material: Aluminium, natural anodized or powder coated white.					
DFK-IM130	Natural anodized White RAL 9016	13/100/95	1	7315885501652 3606480630750	5501650 5501652

Front covers type FCA

Aluminium Front cover					
Front cover for service carriers with 80 mm front opening. Material: Aluminium, natural anodized or powder coated white.					
FCA-F80	Natural anodized White RAL 9016	80/13/2500	8	7315885580084 7315880006930	5580080 5580088

Wall brackets with accessories type TTA

Adjustable wall bracket					
Adjustable wall bracket for wall-mounting of trunking. Suitable for use together with ventilation-rib holder kit TTA-GH1 or rib holder TTA-GH6. Material: Steel, unpainted/Aluminium.					
TTA-TN50	Adjustable 50–70	121/67/50	10	7315885583573	5583570
TTA-TN70	Adjustable 70–110	121/67/70	10	7315880095118	5583572
TTA-TN110	Adjustable 110–170	121/67/110	10	7315880095125	5583574
TTA-TN160	Adjustable 160–260	180/67/160	10	7315880095132	5583576
Adjustable wall bracket including loose plastic rib holder TTA-GH1 with steel clamp, for wall-mounting of trunking. The loose rib holder is suitable for ventilation ribs TTA-G10 and TTA-G3. Material: Steel, unpainted, PC/ABS.					
TTA-KVS60A	Adjustable 30–60	77/30/28	10	7315885583603	5583608
Fixed wall bracket					
Fixed wall bracket for wall-mounting of trunking. Material: Aluminium, untreated.					
TTA-KV15	—	113/23/28	10	7315885583016	5583010
TTA-KV35	—	130/43/28	10	7315880010241	5583014
Fixed wall bracket with integrated rib holder					
Fixed wall bracket with integrated rib holder, for wall-mounting of trunking. The integrated rib holder is suitable for ventilation rib TTA-G10. Material: Aluminium, untreated.					
TTA-KV35-1	—	130/43/28	10	7315880010258	5583016
TTA-KV56-2	—	130/64/28	10	7315880010265	5583018
TTA-KV79-3	—	130/86/28	10	7315885583023	5583020
TTA-KV101-4	—	132/109/28	10	7315880010272	5583022
TTA-KV123-5	—	132/131/28	10	7315880010289	5583024
TTA-KV146-6	—	130/153/28	10	7315880010296	5583026

Wall brackets with accessories type TTA

Type	Colour	Dimensions A/B/C (mm)	Qty per package	EAN code	Ref. No.
Fixed wall bracket with loose rib holder					
Fixed wall bracket including loose plastic rib holder TTA-GH1 with steel clamp, for wall-mounting of trunking. The loose rib holder is suitable for ventilation ribs TTA-G10 and TTA-G3. Material: Aluminium, untreated, PC/ABS.					
TTA-KV35	—	132/43/28	10	7315885583030	5583034
TTA-KV56	—	132/64/28	10	7315880029915	5583036
TTA-KV79	—	132/86/28	10	7315880029922	5583038
TTA-KV101	—	132/109/28	10	7315885583047	5583040
TTA-KV123	—	132/131/28	10	7315880029939	5583042
TTA-KV146	—	132/153/28	10	7315880029946	5583044
Ventilation-rib holder					
Rib holder to fix ventilation ribs G3 and G10 on the wall brackets. Suitable for TTA-TN, TTA-KV and TTA-KVS. Material: PC/ABS.					
TTA-GH6	Grey	15/120/34	10	7315880030034	5590453
Ventilation-rib holder, kit					
Kit including 10 plastic rib holders and 10 steel clamps, to be used to fix ventilation ribs G3 and G10 on the wall brackets. Suitable for TTA-TN, TTA-KV and TTA-KVS. Material: PC/ABS (rib holder), steel (clamp).					
TTA-GH1	Grey	15/120/34	1	7315880079873	5590456
Ventilation rib					
Ventilation rib to be used together with wall bracket for trunking and ventilation-rib holder. Material: Aluminium, natural anodized or powder coated.					
TTA-G3	Anodized White RAL 9016	20/3/2500	40	7315885590489 7315880028949	5590480 5590481
TTA-G10	Anodized White RAL 9016	20/10/2500	16	7315885590434 7315880011842	5590430 5590431
Joining piece					
Joining piece to be used for jointing of ventilation ribs. Material: Aluminium, untreated.					
TTA-GS3	—	9/6/30	10	7315880028956	5590486
TTA-GS10	—	13/10/100	8	7315885590441	5590440
Washer					
Washer to be used between bracket and wall or trunking and wall, to compensate for uneven walls. Material: PP.					
TTA-KM3	Grey	114/3/38	10	7315885583405	5583408
TTA-KM5	Grey	114/5/38	10	7315885583412	5583410

Cable shelves with accessories type TTI

Single cable shelf					
Single cable shelf to be used to divide the trunking into compartments, for the separation of cables. Material: PVC or aluminium, see below.					
TTI-KH72	Anodized aluminium White PVC	12/62/500	50 50	7315880011576 7315880011583	5590312 5590314
Double cable shelf					
Double cable shelf to be used to divide the trunking into compartments, for the separation of cables. Material: PVC or PC/ABS, see below.					
TTI-KH272	White PVC	64/59/500	20	7315880071341	5590319
TTI-KH272C	White PC/ABS	64/59/500	20	7315880089377	5590311

Cable shelves with accessories type TTI

Type	Colour	Dimensions A/B/C (mm)	Qty per package	EAN code	Ref. No.
Cable clip					
Cable clip to be snap-fitted onto the cable shelf, used to retain the cables in their place. Material: PA (TTI-KL52), ABS (TTI-KHK).					
TTI-KL52 For TTI-KH252	Black	13/25/40	50	7315880011644	5590346
TTI-KHK For TTI-KH72	Brown	6/43/34	100	7315885590342	5590340

Other accessories type TTI

Mounting washer					
Mounting washer provided with screw hole for mounting to the wall by means of a countersunk screw. The mounting washers are to be placed on the wall along a chalk lining. The trunking is then easily hung on the mounting washers and screw-fixed directly to the wall. Material: PA, injection moulded.					
TTI-MB	Black	5/15/19	100	7315885590182	5590180
Cup washer					
Cup washer to cover screw heads inside the trunking in order to protect single-insulated cables. Material: PE.					
TTI-KB	Black	Ø13	100	7315885590526	5590520
Earthing clamps					
Earthing clamp for aluminium trunking and accessories. To be turned into the earthing slot of the trunking. Intended for an area of max. 4 mm ² . Material: Steel, zinc coated.					
TTI-JB	—	18/12/22	10	7315885590502	5590500
Earth wires					
Earth wire including cable clip, to be used to bond the front cover to the trunking base. The cable clip has an extra connection for an additional cable clip. Material: Copper (conductor).					
TTI-JKE300	Yellow green	Length 300	10	7332418015530	5590513
Sound insulation strip					
Sound insulation strip to be used for sound absorbing up to 53 dB when a trunking passes through a wall. Supplied in a set of four for up to four compartments. Material: Foam plastic.					
TTI-T3045	Black	30/45/350	1	7315885590410	5590410
TTI-T5070	Black	50/70/350	1	7315880011828	5590414

Design and dimensions

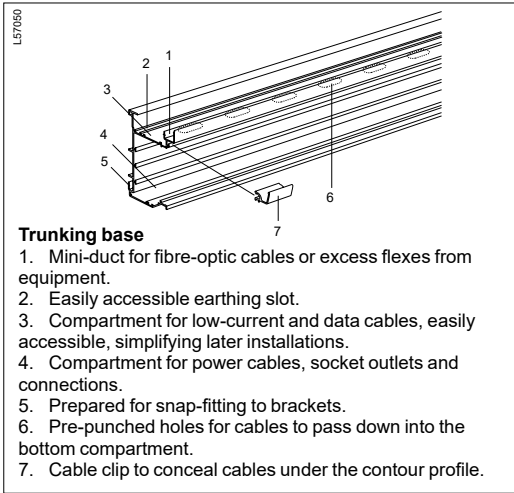
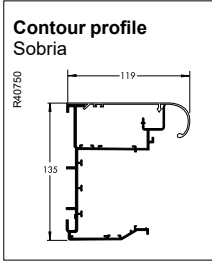

Trunking base

1. Mini-duct for fibre-optic cables or excess flexes from equipment.
2. Easily accessible earthing slot.
3. Compartment for low-current and data cables, easily accessible, simplifying later installations.
4. Compartment for power cables, socket outlets and connections.
5. Prepared for snap-fitting to brackets.
6. Pre-punched holes for cables to pass down into the bottom compartment.
7. Cable clip to conceal cables under the contour profile.

Tests of electric fields

The test was made in a cage that was specially constructed for this purpose. During the test the background radiation was measured to 0.2 V.

Results from the test

Combination	Electric alternating field measured 30 cm straight from the front, V/m	
	DFK-130	EKK EKLK
Unearthed DFK, without outlets	4.4	3.8
Earthed DFK, without outlets	0.2	0.2

Load

Maximum vertical load	800 N
-----------------------	-------

Cable capacity

Compartment No.	Cross-section, mm ² Per compartment	Max. Ø cable, mm	Area (mm ²) used when		
			40% full	50% full	60% full
1	2831	36	1132	1415	1698
2	5264	45	2105	2632	3158

Standards and approvals

Standard	EN 50085.
Approvals	SEMKO, NEMKO.

Material data DFK

Material	Extruded aluminium, SS 4104-06, DIN Al Mg Si 0.5, BS H9
Surface treatment	Natural anodizing 5–10 µm or powder coating
Chemical resistance	Resistant to most first acids and organic solvents. Not resistant to most strong acids (except nitric acid) and alkali.
Colour spec.	• White RAL 9016 • Optional acc. to customer choice (use the Ref. No. and add the desired RAL colour and gloss)
Material	Sheet steel DX S1D acc. to SS-EN 10142, 10147 and 10215
Surface treatment	Both sides zinc coated. Powder coating.
Colour spec.	• White RAL 9016 • Aluminium metallic
Material	PC/ABS (polycarbonate/acrylonitrile-butadiene-styrene, halogen-free)
Fire rating	UL 94 V0
Colour	Grey
Material	PA (polyamide, halogen-free)
Fire rating	UL 94 V0
Colours	• White • Black.
Material	PE (polyethylene, halogen-free)
Fire rating	UL 94 HB
Colour	Green

Material data FCA

Material	Extruded aluminium
Surface treatment	Natural anodizing or powder coating
Colour spec.	White RAL 9016

Material data TTA

Material	Aluminium SS 4104
Colour spec.	• Unpainted • White RAL 9016
Material	Steel
Surface treatment	Galvanized
Colour spec.	Unpainted
Material	PC/ABS (polycarbonate/acrylonitrile-butadiene-styrene)
Colour.	Grey
Material	PP (polypropylene)
Colour	Grey

Material data TTI

Material	Aluminium SS 4106
Surface treatment	Natural anodizing 5–10 µm
Material	PC/ABS (polycarbonate/acrylonitrile-butadiene-styrene)
Fire rating	UL 94 V0
Impact resistance	2 J (medium acc. to EN 50085-1)
Colour	White
Material	ABS (acrylonitrile-butadiene-styrene)
Colour spec.	Brown NCS 8203-Y63R
Material	PVC (self-extinguishing, lead and cadmium-free)
Colour	White, unspecified
Material	PE (polyethylene, halogen-free)
Fire rating	UL 94 HB
Colour	Black
Material	PA (polyamide)
Fire rating	UL 94 V-0
Colour	Black
Material	Stainless steel SS



TEK PVC and NPT Halogen-free plastic trunking

High-quality installations faster than ever

TEK is our best-seller, with more than 6 million metres of sold trunking. Generic design, versatile functions and unbeatable availability at the wholesalers, are the key players in TEK's success story. The halogen-free equivalent, NPT, comes with the same benefits.



Super-high finish
Both TEK and NPT have a high-gloss surface, which is UV-stable and easy to keep clean. The trunking is delivered with a protective film that does not need to be removed until the installation has been completed.

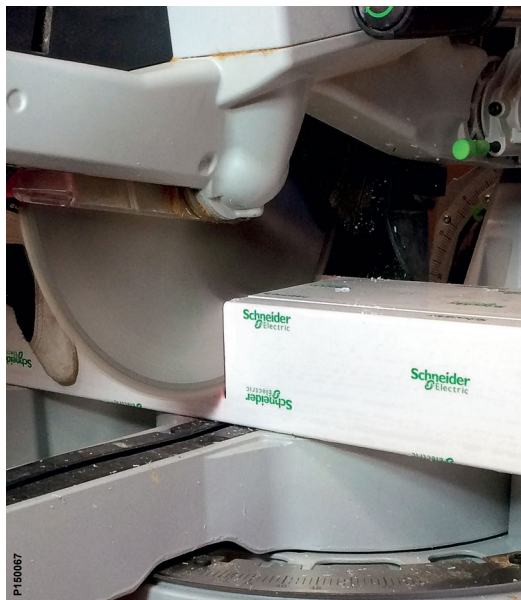

The everyday trunking

Thanks to the workable plastic material, cutting is done quickly and easily. The plastic trunking is also suitable as feeder.



Adjustable corners

The adjustable inner corner pieces suit angles between 90 and 135°, whereas the outer corners fit angles 80-135°. IP40 when mounted directly onto the wall.









Protective foil

On delivery, the trunking and accessories are wrapped in protective foil to prevent damage during the installation.



Halogen-free

Examples of halogens, or halogen elements, are chlorine, bromine and iodine. Halogens are often used as disinfectants and flame retardants, but are nevertheless generally toxic. The use of halogen-free materials is crucial when it comes to reducing hazardous gases in case of a fire, and making less environmental impact in general.

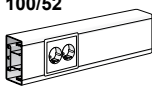
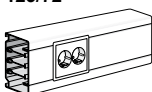
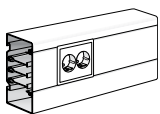
Product Range, type TEK							
In the matrix: Type Art. No. Material/Finish	 P61409	 P61985	 P63691 P61414	 P63692 P61419	 P61422	 P61413	
TEK-	Trunking base	Front cover	Internal corner	External corner	Bend, 90°	T-piece	
L38960 100/52 	TEK-U100 5522020 WN 5522029 WR TEK-UH100* 5522010 WN	FCA-F80 5580080 AN 5580089 AO 5580060 WN 5580069 WR	TEK-IH100 5576101 WN TEK-IHH100* 5576100 WN Adjustable TTI-IH100 5589150 WN	TEK-YH100 5576111 WN TEK-YHH100* 5576110 WN Adjustable TTI-YH100 5589500 WN	TEK-LS100 5576121 WN 5576129 WR TEK-LSH100* 5576120 WN	TEK-TSH100* 5576130 WN	
L38950 123/72 	TEK-U123 5526010 WN 5526019 WR INS60600 BL	FCA-F80 5580080 AN 5580089 AO 5580060 WN 5580069 WR INS60604 BL	TEK-IH123 5526510 WN 5526519 WR INS60601 BL Adjustable TTI-IH123 5589170 WN	TEK-YH123 5526520 WN INS60602 BL Adjustable TTI-YH123 5589520 WN	TEK-LS123 5526530 WN 5526539 WR INS60603 BL	TEK-TS123 5576340 WN 5576349 WR	
L38970 161-3/72 	TEK-U161-3 5532020 WN 5532021 WR	FCA-F80 5580080 AN 5580089 AO 5580060 WN 5580069 WR	TEK-IH161-3 5532600 WN 5532601 WR	TEK-YH161-3 5532610 WN	TEK-LSU161-3 5532620 WN ↑ TEK-LSN161-3 5532630 WN ↓ 5532631 WR ↓	TEK-TSU161-3 5532640 WN ↑ TEK-TSN161-3 5532650 WN ↓	

* With pre-punched back-side for cable entry.

AN= Aluminium, Natural anodized
 AO= Aluminium, Optional powder coated
 AW= Aluminium, White powder coated
 WN= White RAL 9016
 WR= White RAL 9010
 GR= Grey
 BL=Black

← = Left hand
 → = Right hand
 ↑ = Up, riser
 ↓ = Down, dropper

Installation trunking

 P 61424	 P 61496	 P 61429 P 61428	 P 61404 P 61405	 P 61336 P 61314	 P 61513	 P 61515
Stop end	Joint cover	Wall collar	Cable shelf	Cable clip	Joining piece	Support. piece
TEK-ES100 5591100 WN 5591109 WR	TTI-US100 5590002 AW	TTI-R2 100 5590720 WN TTI-CR100 5594511 WN	TTI-KH252 5590322	TTI-KL52 5590346		
TTI-ES123 5590232 WN 5590237 WR 5590238 WN INS60606 BL	TTI-US123 5590036 AW 5900041 AW 5590039 AO INS60605 BL	TTI-CR123 5594576 WN TTI-R2 123 5590740 WN	TTI-KH72 5590314 TTI-KH272 5590319	TTI-KHK 5590340	TTI-JP123 5590115	
TEK-ES161-3 5532665 WN 5532666 WR	TTI-US161-3 5590075 AW 5590073 AO	TTI-CR161 5594616 WN 5594615 WR TTI-R2 161 5590760 WN	TTI-KH72 5590314 TTI-KH272 5590319	TTI-KHK 5590340	TTI-JP123 5590115	TEK-K161-3 5590341

Length material

Type	Colour	Dimensions A/B/C (mm)	Qty per package	EAN code	Ref. No.		
Trunking base							
Trunking base with F80® front opening. Can be divided into compartments by means of cable shelves. To be used as perimeter trunking, mounted direct onto the wall or on brackets. Also suitable as feeder trunking. Four support pieces included in each length of TEK-/161-3. Compatible with FCA-F80, MIB boxes, TTI cable shelves for 52 and 72 mm deep trunking, TTA brackets. Material: PVC.							
P61408		TEK-U100	White RAL 9010 White RAL 9016	100/52/2500	4	7315880021780 7315885522022	5522029 5522020
		TEK-UH100 With pre-punched holes in the back	White RAL 9016	100/52/2550	4	7315885522015	5522010
P61409		TEK-U123	White RAL 9010 White RAL 9016 Black	123/72/2500	4	7315880006121 7315885526013 3606481069238	5526019 5526010 INS60600
		TEK-U161-3	White RAL 9010 White RAL 9016	161/72/2500	4	7315880035145 7315885532021	5532021 5532020

Corner sections

Internal corners							
Internal corner with F80® front opening. Can be divided into compartments by means of cable shelves. TEK-IHH100 has pre-punched holes for cable passage. Material: PVC.							
P61420		TEK-IH100	White RAL 9016	100/200/200	1	7315880066701	5576101
		TEK-IHH100 With pre-punched holes in the back	White RAL 9016	100/200/200	1	7315885576100	5576100
P61414		TEK-IH123	White RAL 9010 White RAL 9016 Black	123/200/200	1	7315880006152 7315885526518 3606481069245	5526519 5526510 INS60601
		TEK-IH161-3	White RAL 9010 White RAL 9016	161/200/200	1	7315880035169 7315885532601	5532601 5532600
P61411							
Internal corner, adjustable, type TTI							
Open internal corner that covers the opening between two trunking lengths installed in an angle to one another. The corner section is made up by two parts which can be moved against one another to create the required angle. Angle adjustment 90–135°. Degree of protection: IP40, provided that the trunking system is mounted direct on the wall. For TTI-IH123, covering plate TTI-BP can be used to reach IP20 when the system is mounted on brackets. Material: PC/ABS.							
P83661		TTI-IH100	White RAL 9016	100/52/140	1	7315885589155	5589150
		TTI-IH123	White RAL 9016	123/72/145	1	7315885589179	5589170
External corner kits							
External corner with F80® front opening. Can be divided into compartments by means of cable shelves. TEK-IHH100 has pre-punched holes for cable passage. Supplied with front piece. Material: PVC.							
P61417		TEK-YH100	White RAL 9016	100/200/200	1	7315880006718	5576111
		TEK-YHH100 With pre-punched holes in the back	White RAL 9016	100/200/200	1	7315885576117	5576110
P61419		TEK-YH123	White RAL 9016 Black	123/200/200	1	7315885526525 3606481075246	5526520 INS60602
		TEK-YH161-3	White RAL 9016	161/200/200	1	7315885532618	5532610

Corner sections

Type	Colour	Dimensions A/B/C (mm)		Qty per package	EAN code	Ref. No.
External corner, adjustable, type TTI						
Open external corner that covers the opening between two trunking lengths installed in an angle to one another. The corner section is made up by two parts which can be moved against one another to create the required angle. Angle adjustment 85–135°.						
Degree of protection: IP40, provided that the trunking system is mounted direct on the wall. For TTY-IH123, covering plate TTI-BP can be used to reach IP20 when the system is mounted on brackets.						
Material: PC/ABS.						
TTI-YH100	White RAL 9016	100/52/110		1	7315885589506	5589500
TTI-YH123	White RAL 9016	123/72/145		1	7315885589520	5589520

Bends

Bend kit, 90°						
90° bend with F80® front opening. Can be divided into compartments by means of cable shelves. TEK-LSH100 has pre-punched holes for cable passage. Supplied with 225 mm front piece.						
Material: PVC.						
TEK-LS100	White RAL 9010 White RAL 9016	200/52/200		1	7315880021940 7315880006725	5576129 5576121
TEK-LSH100	White RAL 9016	200/52/200		1	7315885576124	5576120
With pre-punched holes in the back						
TEK-LS123	White RAL 9010 White RAL 9016 Black	200/72/200		1	7315880006213 7315885526532 3606481069252	5526539 5526530 INS60603
T-piece, kit						
T-piece with F80® front opening. Can be divided into compartments by means of cable shelves. TEK-TSH100 has pre-punched holes for cable passage. Supplied with 225 mm front piece.						
Material: PVC.						
TEK-TSH100	White RAL 9016	250/52/400		1	7315885576131	5576130
With pre-punched holes in the back						
TEK-TS123	White RAL 9010 White RAL 9016	200/72/280		1	7315880006756 7315885576346	5576349 5576340
TEK-TSU161-3	White RAL 9016	260/72/360		1	7315885532649	5532640
Rising						
TEK-TSN161-3	White RAL 9016	260/72/360		1	7315885532656	5532650
Dropping						

Stop ends

Stop ends type TEK and TTI						
Stop end for snap-fitting on the trunking end. Both for left-hand and right-hand mounting.						
Material: ABS.						
TEK-ES100	White RAL 9010 White RAL 9016	100/29/52		1	7315880022183 7315885591103	5591109 5591100
TTI-ES123	White RAL 9010 White RAL 9016 Black	123/—/72		1	7315880011354 7315880011323 3606481069283	5590237 5590232 INS60606
TEK-ES161-3	White RAL 9010 White RAL 9016	161/21/72		1	7315880060888 7315880060871	5532666 5532665

Front covers type FCA

Type	Colour	Dimensions A/B/C (mm)		Qty per package	EAN code	Ref. No.
Aluminium Front covers						
Front cover for service carriers with 40 and 80 mm front opening respectively. Material: Aluminium, natural anodized or powder coated.						
FCA-F80	White RAL 9016	80/13/2500		8	7315880006930	5580088
PVC Front covers						
Front cover for service carriers with 80 mm front opening. Material: PVC.						
FCA-F80	White RAL 9016 White RAL 9010 Black	80/13/2500		8	7315885580060 7315880006909 3606481069269	5580060 5580069 INS60604
Front cover brace						
Front cover brace for front cover F80. Used to maintain correct front cover retention in cases of heavy cable loads. Material: Steel, electroplated.						
FCA-B80	—	10/14/81		10	7315885580916	5580900

Wall brackets with accessories type TTA

Adjustable wall brackets						
Adjustable wall bracket for wall-mounting of trunking. Suitable for use together with ventilation-rib holder kit TTA-GH1 or rib holder TTA-GH6. Material: Steel, unpainted/Aluminium.						
TTA-TN50	Adjustable 50–70	121/67/50		10	7315885583573	5583570
TTA-TN70	Adjustable 70–110	121/67/70		10	7315880095118	5583572
TTA-TN110	Adjustable 110–170	121/67/110		10	7315880095125	5583574
TTA-TN160	Adjustable 160–260	180/67/160		10	7315880095132	5583576
Adjustable wall bracket including loose plastic rib holder TTA-GH1 with steel clamp, for wall-mounting of trunking. The loose rib holder is suitable for ventilation ribs TTA-G10 and TTA-G3. Material: Steel, unpainted, PC/ABS.						
TTA-KVS60A	Adjustable 30–60	77/30/28		10	7315885583603	5583608
Fixed wall bracket						
Fixed wall bracket for wall-mounting of trunking. Material: Aluminium, untreated.						
TTA-KV15	—	113/23/28		10	7315885583016	5583010
TTA-KV35	—	130/43/28		10	7315880010241	5583014
Fixed wall bracket with integrated rib holder						
Fixed wall bracket with integrated rib holder, for wall-mounting of trunking. The integrated rib holder is suitable for ventilation rib TTA-G10. Material: Aluminium, untreated.						
TTA-KV35-1	—	130/43/28		10	7315880010258	5583016
TTA-KV56-2	—	130/64/28		10	7315880010265	5583018
TTA-KV79-3	—	130/86/28		10	7315885583023	5583020
TTA-KV101-4	—	132/109/28		10	7315880010272	5583022
TTA-KV123-5	—	132/131/28		10	7315880010289	5583024
TTA-KV146-6	—	130/153/28		10	7315880010296	5583026

Wall brackets with accessories type TTA

Type	Colour	Dimensions A/B/C (mm)	Qty per package	EAN code	Ref. No.
Fixed wall bracket with loose rib holder					
Fixed wall bracket including loose plastic rib holder TTA-GH1 with steel clamp, for wall-mounting of trunking. The loose rib holder is suitable for ventilation ribs TTA-G10 and TTA-G3. Material: Aluminium, untreated, PC/ABS.					
TTA-KV35	—	132/43/28	10	7315885583030	5583034
TTA-KV56	—	132/64/28	10	7315880029915	5583036
TTA-KV79	—	132/86/28	10	7315880029922	5583038
TTA-KV101	—	132/109/28	10	7315885583047	5583040
TTA-KV123	—	132/131/28	10	7315880029939	5583042
TTA-KV146	—	132/153/28	10	7315880029946	5583044
Ventilation-rib holder					
Rib holder to fix ventilation ribs G3 and G10 on the wall brackets. Suitable for TTA-TN, TTA-KV and TTA-KVS. Material: PC/ABS.					
TTA-GH6	Grey	15/120/34	10	7315880030034	5590453
Ventilation-rib holder, kit					
Kit including 10 plastic rib holders and 10 steel clamps, to be used to fix ventilation ribs G3 and G10 on the wall brackets. Suitable for TTA-BT, TTA-TN, TTA-WG, TTA-KV and TTA-KVS. Material: PC/ABS (rib holder), steel (clamp).					
TTA-GH1	Grey	15/120/34	1	7315880079873	5590456
Ventilation rib					
Ventilation rib to be used together with wall bracket for trunking and ventilation-rib holder. Material: Aluminium, natural anodized or powder coated.					
TTA-G3	White RAL 9016 White RAL 9010	20/3/2500	40	7315880028949 7315880031987	5590481 5590482
TTA-G10	White RAL 9010 White RAL 9016	20/10/2500	16	7315880031956 7315880011842	5590424 5590431
Joining piece					
Joining piece to be used for jointing of ventilation ribs. Material: Aluminium, untreated.					
TTA-GS3	—	9/6/30	10	7315880028956	5590486
TTA-GS10	—	13/10/100	8	7315885590441	5590440
Washer					
Washer to be used between bracket and wall or trunking and wall, to compensate for uneven walls. Material: PP.					
TTA-KM3	Grey	114/3/38	10	7315885583405	5583408
TTA-KM5	Grey	114/5/38	10	7315885583412	5583410

Cable shelves type TTI

Single cable shelf					
Single cable shelf to be used to divide the trunking into compartments, for the separation of cables. Material: PVC.					
TTI-KH52 For 52 mm deep trunking	White	10/46/500	50	7315885590311	5590310
TTI-KH72 For 72 mm deep trunking	White	12/62/500	50	7315880011583	5590314

Cable shelves type TTI

Type	Colour	Dimensions A/B/C (mm)	Qty per package	EAN code	Ref. No.
------	--------	-----------------------	-----------------	----------	----------

Double cable shelf

Double cable shelf to be used to divide the trunking into compartments, for the separation of cables.
Material: PVC or PC/ABS, see below.



TTI-KH252 For 52 mm deep trunking	White PVC	58/46/500	20	7315885590328	5590322
--------------------------------------	-----------	-----------	----	---------------	----------------



TTI-KH272 For 72 mm deep trunking	White PVC	64/59/500	20	7315880071341	5590319
--------------------------------------	-----------	-----------	----	---------------	----------------

Cable clip

Cable clip to be snap-fitted onto the cable shelf, used to retain the cables in their place.
Material: PA (TTI-KL52), ABS (TTI-KHK).



TTI-KL52 For TTI-KH252	Black	13/25/40	50	7315880011644	5590346
---------------------------	-------	----------	----	---------------	----------------

TTI-KHK For TTI-KH72	Brown	6/43/34	100	7315885590342	5590340
-------------------------	-------	---------	-----	---------------	----------------

Joint cover pieces type TTI

Joint cover piece, kit

Joint cover kits including two or three joint cover pieces to cover joints between trunking sections.
Material: Aluminium, powder coated.

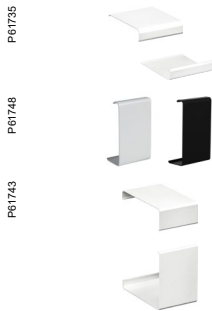

TTI-US100 For 52 mm deep trunking	White RAL 9016	—/45/52	10	7315880037699	5590002
--------------------------------------	----------------	---------	----	---------------	----------------

TTI-US123 For 72 mm deep trunking	White RAL 9016 Black	—/45/72	10	7315880010999 3606481069276	5590036 INS60605
--------------------------------------	-------------------------	---------	----	--------------------------------	-----------------------------------

TTI-US161-3 For 72 mm deep trunking	White RAL 9016	—/45/72	10	7315880046080	5590075
--	----------------	---------	----	---------------	----------------

Wall frames/collars type TTI

Wall frame

Wall frame made up by two parts which are assembled and mounted on the trunking by means of two rubber mouldings. The frame has a flange against the trunking. To be used to cover a trunking passage through the wall or to make an attractive finish of the trunking against a wall.
Material: ABS.



TTI-CR100 For 100x52 mm trunking	White RAL 9016	170/25/120	1	7315885594517	5594511
-------------------------------------	----------------	------------	---	---------------	----------------

TTI-CR123 For 123x72 mm trunking	White RAL 9016	193/25/140	1	7315880066637	5594576
-------------------------------------	----------------	------------	---	---------------	----------------

TTI-CR161 For 161x72 mm trunking	White RAL 9016 White RAL 9010	231/25/140	1	7315880066644 7315885594616	5594616 5594615
-------------------------------------	----------------------------------	------------	---	--------------------------------	----------------------------------

Wall collar







Wall collar made up by two parts that are snapped together. To be used to cover a trunking passage through the wall or to make an attractive finish of the trunking against a wall.
Material: ABS.



TTI-R2 100 For 100x52 mm trunking	White RAL 9010	161/2.5/103	1	7315880028048	5590720
--------------------------------------	----------------	-------------	---	---------------	----------------

TTI-R2 123 For 123x72 mm trunking	White RAL 9016	199/8/142	1	7315885590748	5590740
--------------------------------------	----------------	-----------	---	---------------	----------------

TTI-R2 161 For 161x72 mm trunking	White RAL 9016	238/8/142	1	7315885590762	5590760
--------------------------------------	----------------	-----------	---	---------------	----------------

Other accessories type TEK and TTI						
Type	Colour	Dimensions A/B/C (mm)		Qty per package	EAN code	Ref. No.
Supporting piece						
Supporting piece to be used as a support when mounting front F80®. To be inserted under the front, between the front and back walls of the trunking base. Suitable for TEK-161-3. Material: PC/ABS.						
P61515 	White	18/67.2/60		4	7315880037705	5590341
Joining piece						
Internal joining piece to be used when joining trunking parts. Suitable for TEK -123 and TEK-161-3. Material: PC/ABS.						
P61513 	White	37/67/100		1	7315880022046	5590115
Bracket						
Bracket for wall mounting of TEK-UH100, adjusted to the pre-punched holes of the trunking. To be screw-fixed to the wall. Material: PP.						
P61519 	Grey	20/20/67		50	7315885591813	5591810
Mounting washer						
Mounting washer provided with screw hole for mounting to the wall by means of a countersunk screw. The mounting washers are to be placed on the wall along a chalk lining. The trunking is then easily hung on the mounting washers and screw-fixed directly to the wall. Suitable for TEK-123 and 161-3. Material: PA, injection moulded.						
P61881 	Black	5/15/19		100	7315885590182	5590180
Cup washer						
Cup washer to cover screw heads inside the trunking in order to protect single-insulated cables. Material: PE.						
P61937 	Black	Ø13		100	7315885590526	5590520
Sound insulation strips						
Sound insulation strip to be used for sound absorbing up to 53 dB when a trunking passes through a wall. Supplied in a set of four for up to four compartments. Material: Foam plastic.						
P61537 	Black	30/45/350		1	7315885590410	5590410
	Black	50/70/350		1	7315880011828	5590414

Design and dimensions

TEK-100/52

For wall surface mounting or on a spacer.

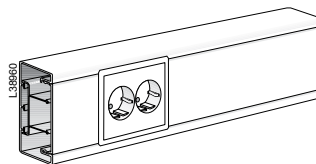
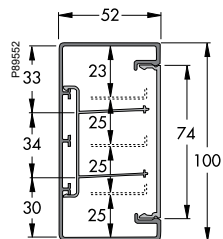

TEK-123/72

For wall surface mounting or on brackets.

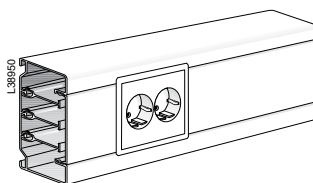
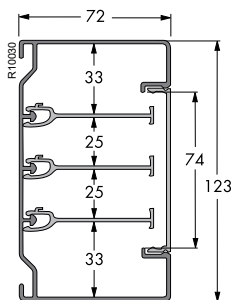

TEK-161-3/72

For wall surface mounting or on brackets.

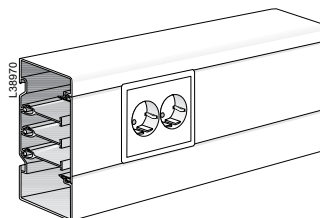
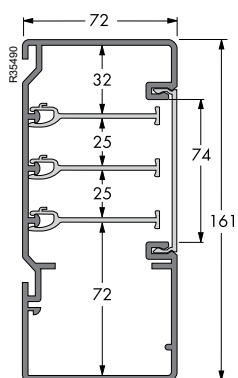

Exploded view

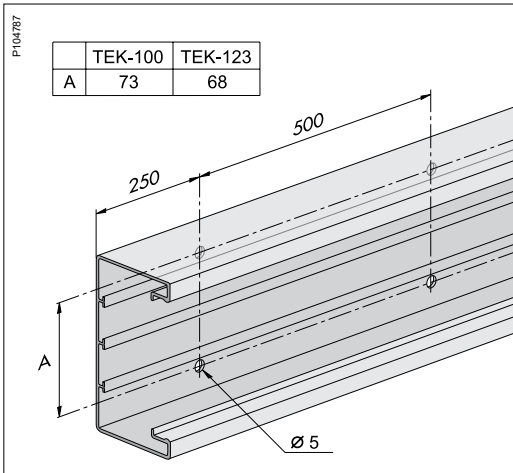
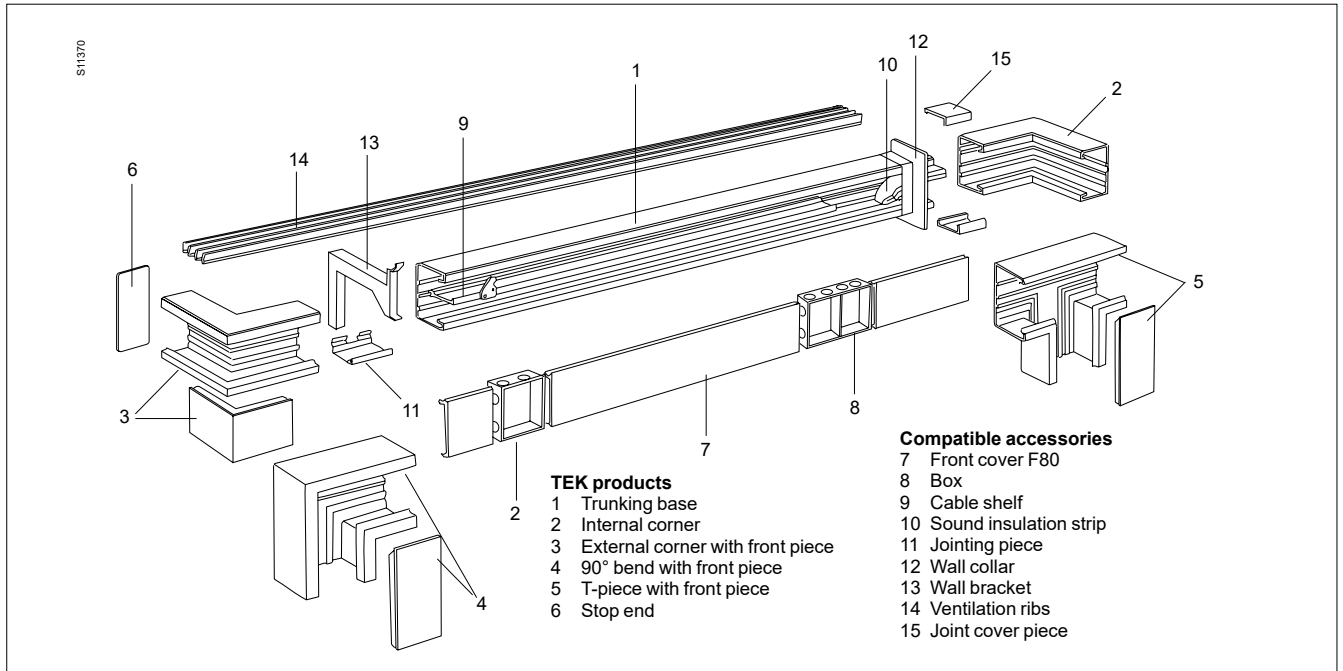

Standards & approvals

Standards	EN 50085-1:1997+A1:1998
	SS 424 10 02:1993
	KEMA 55A:1984
	CE
Approvals	TEK-100 SEMKO, NEMKO, KEMA
	TEK-123 SEMKO, NEMKO, VDE, SETI, KEMA
	TEK-161-3 SEMKO, NEMKO, VDE, KEMA

Material data TEK

Material	PVC, self-extinguishing, cadmium-free and lead-free
Colour spec.	<ul style="list-style-type: none"> • White RAL 9016 • White RAL 9010
Material	ABS (acrylonitrile-butadiene-styrene)
Colour spec.	<ul style="list-style-type: none"> • White RAL 9016 • White RAL 9010
Material	PC/ABS (polycarbonate/acrylonitrile-butadiene-styrene)
Colour	White
Material	PP (polypropylene)
Colour	Grey

Material data FCA

Material	Extruded aluminium
Surface treatment	Powder coating
Colour spec.	<ul style="list-style-type: none"> • White RAL 9016 • White RAL 9010
Material	PVC (self-extinguishing, lead and cadmium-free)
Fire rating	UL 94 V0 (0.8 mm)
Colour spec.	<ul style="list-style-type: none"> • White RAL 9010 • White RAL 9016

Material data TTA

Material	Steel
Surface treatment	Galvanized
Colour spec.	Unpainted
Material	Aluminium SS 4104
Colour spec.	<ul style="list-style-type: none"> • Unpainted • White RAL 9010 • White RAL 9016
Material	PC/ABS (polycarbonate/acrylonitrile-butadiene-styrene)
Colour.	Grey
Material	PP (polypropylene)
Colour	Grey

Material data TTI

Material	PC/ABS (polycarbonate/acrylonitrile-butadiene-styrene)
Fire rating	UL 94 V0
Impact resistance	2 J (medium acc. to EN 50085-1)
Colour spec.	White RAL 9010
Material	ABS (acrylonitrile-butadiene-styrene)
Colour spec.	<ul style="list-style-type: none"> White RAL 9016 White RAL 9010 Brown NCS 8203-Y63R
Material	PVC (self-extinguishing, lead and cadmium-free)
Colour	White, unspecified
Material	PE (polyethylene, halogen-free)
Fire rating	UL 94 HB
Chemical resistance	Resistant to lubricants, fuel, refrigerants, enamels and paints, detergents and degreasing agents. Not resistant to acids.
Colour	Black
Material	PA (polyamide)
Fire rating	UL 94 V-0
Colour	Black
Material	Stainless steel SS
Material	Aluminium SS 4106
Surface treatment	Powder coating
Colour spec.	<ul style="list-style-type: none"> White RAL 9016 White RAL 9010

Operative data

Temperature range	From -20° to +60°C
Degree of protection	IP20
Chemical resistance	For extruded profiles in acc. with ISO Technical Report 7473

Cable capacity

TEK-161-3/72

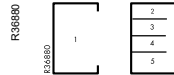

Comp No	Max Ø mm	Cross section area mm ²	Cable capacity, mm ²		
			40%	50%	60%
Without mounting boxes					
1	60	8918	3567	4459	5351
2	30	1700	680	850	1020
3	22	1170	468	585	702
4	22	1170	468	585	702
5	56	4298	1719	2149	2579
With 40 mm deep MIB & CYB boxes					
1	56	6652	2661	3326	3991
2	24	1400	560	700	840
3	16	440	176	220	264
4	16	440	176	220	264
5	56	3847	1539	1924	2308
With 30 mm deep CYB boxes					
1	56	7558	3023	3779	4535
2	28	1485	594	743	891
3	20	700	280	350	420
4	20	700	280	350	420
5	56	4538	1815	2269	2723

Cross section area matrix, mm²

Matrix to be used in conjunction with cable capacity tables above.

Round cable Ø mm	Number of cables									
	1	2	3	4	5	6	7	8	9	10
3	7.1	14.2	21.3	28.4	35.5	42.6	49.7	56.8	63.9	71
4	12.6	25.2	37.8	50.4	63.0	75.6	88.2	101	113	12
5	19.6	39.2	58.8	78.4	98.0	118	137	157	176	196
6	28.3	56.6	84.9	113	142	170	198	226	255	283
7	38.5	77	116	154	193	231	270	308	347	385
8	50.0	100	150	200	250	300	350	400	450	500
9	63.7	127	191	255	319	382	446	510	573	637
10	78.5	157	236	314	393	471	550	628	707	785
11	95	190	285	380	475	570	665	760	855	950
12	113	226	339	452	565	678	791	904	1017	1130
13	133	266	399	532	665	798	931	1064	1197	1330
14	154	308	462	616	770	924	1078	1232	1386	1540
15	177	354	531	708	885	1062	1239	1416	1593	1770
16	201	402	603	804	1005	1206	1407	1608	1809	2010
17	227	454	681	908	1135	1362	1589	1816	2043	2270
18	255	510	765	1020	1275	1530	1785	2040	2295	2550
19	284	568	852	1136	1420	1704	1988	2272	2556	2840
20	315	630	945	1260	1575	1890	2205	2520	2835	3150
Oval cable mm	Number of cables									
	1	2	3	4	5	6	7	8	9	10
2 × 3	5.2	10.4	15.6	20.8	26	31.2	36.4	41.6	46.8	52
2 × 5	9.2	18.4	27.6	36.8	46	55.2	64.4	73.6	82.8	92
3 × 6	16.1	32.2	48.3	64.4	80.5	96.6	112.7	128.8	144.9	161
4 × 7	24.6	49.2	73.8	98.4	123	147.6	172.2	196.8	221.4	246

Cable capacity

TEK-100/52

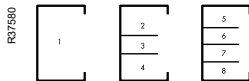

Comp No	Max Ø mm	Cross section area mm ²	Cable capacity, mm ²		
			40%	50%	60%
Without mounting boxes					
1	35	3665	1466	1833	2199
2	25	1110	444	555	666
3	25	902	361	451	541
4	25	1026	410	513	616
5	20	795	318	398	477
6	20	763	305	382	458
7	20	763	305	382	458
8	20	902	361	451	541

With 40 mm deep MIB & CYB boxes					
1	12	1411	564	706	847
2	12	524	210	262	314
3			0	0	0
4	12	527	211	264	316
5	12	536	214	268	322
6	6	92	37	46	55
7	6	101	40	51	61
8	12	539	216	270	323

With 30 mm deep CYB boxes					
1	20	2268	907	1134	1361
2	20	737	295	369	442
3	8	282	113	141	169
4	20	702	281	351	421
5	20	638	255	319	383
6	15	325	130	163	195
7	15	327	131	164	196
8	20	647	259	324	388

TEK-123/72

Without mounting boxes					
1	55	6449	2580	3225	3869
2	35	1651	660	826	991
3	30	1197	479	599	718
4	35	1604	642	802	962
5	30	1661	664	831	997
6	20	1199	480	600	719
7	20	1199	480	600	719
8	30	1916	766	958	1150

With 40 mm deep MIB & CYB boxes					
1	20	4194	1678	2097	2516
2	20	2328	931	1164	1397
3	15	495	198	248	297
4	20	1220	488	610	732
5	20	1433	573	717	860
6	15	476	190	238	286
7	15	476	190	238	286
8	20	1470	588	735	882

With 30 mm deep CYB boxes					
1	30	5052	2021	2526	3031
2	25	1447	579	724	868
3	25	876	350	438	526
4	25	1424	570	712	854
5	25	1527	611	764	916
6	20	742	297	371	445
7	20	742	297	371	445
8	25	2078	831	1039	1247

Performance

Loads

Load between two brackets: 750 N, statical load

Sound insulation

Measurement data per trunking and installation method acc. to ISO 140-10 (reference area 10 m²)

Trunking	Divided	Whole	T5070	T3045	D _{w,8} [dB]	Dw [dB]
TEK-100 distance	X			3x1	58	61
TEK 100 distance	X			3x2	68	68
TEK 100 distance		X		3x1	50	55
TEK 100 distance		X		3x2	62	62
TEK 100 flush	X			3x1	65	66
TEK 100 flush	X			3x2	70	70
TEK 100 flush		X		3x1	55	59
TEK 100 flush		X		3x2	69	69
TEK-123	X		2x1		65	—
TEK-123	X		2x2		66	—
TEK-123		X	2x1		58	—
TEK-123		X	2x2		60	—
TEK-161-3*		X	3x1		55	55
TEK-161-3*		X	3x2		59	59
TEK-161-3*	X		3x1		62	62
TEK-161-3*	X		3x2		66	66

* = Calculated value

Dw = Sound insulation referring to 10 m²

Dw,8 = Sound insulation referring to 10 m² with Swedish additional regulation of 8 dB.

Comments on measurement values

To obtain sound insulation, the type and quantity of the insulating strips must be in accordance with the table.

The column T5070 shows the number of insulating strips of each type respectively. 3x1 implies three insulating strips from one direction and 3x2 implies three strips from either side, i.e. six strips altogether.

Please note that the insulating strips are packed in bundles of four, i.e. the T-number states four strips.

Divided in the table heading means that the trunking is divided inside the wall and whole means that the trunking passes through the wall without being divided.





Electric fields

The measurements refer to TEK with typical cable and outlet configurations.





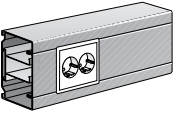

The recommendations from "Svenska Byggnadsstyrelsen" (T:134/1992-02) have served as guidance for the measurements. The limits at 0.5 m distance are 10 V/m for electric fields.

Test objects	Installation trunking: TEK Outlets and connections: CAN								
	Cables: Type 1 = H05 VV-U 5G 1.5, Type 2 = similar to type 1 but with a bi-conductor as shield, 1.5 mm ² (types acc. to CENELEC HD 21 sec. 2.3)								
Instruments	Radians Innova EMM-4								
Voltage	240 V/50 Hz								
Current	19 A nominal								
Point of measurement	The fields were measured at 0.5 m from the objects								
Test results	The values are maximum values for the E-field in V/m.								
	<table border="1"> <thead> <tr> <th>Product</th> <th>M1</th> <th>M3</th> <th>M4</th> </tr> </thead> <tbody> <tr> <td>TEK</td> <td>54</td> <td>1.1</td> <td>20</td> </tr> </tbody> </table>	Product	M1	M3	M4	TEK	54	1.1	20
Product	M1	M3	M4						
TEK	54	1.1	20						
	M1 refers to cable Type 1 in trunking. M3 refers to cable Type 2 with earthed shield in trunking. M4 refers to cable Type 2 with earthed shield and with CAN outlet in trunking.								

Product Range, type NPT

In the matrix: Type Art. No. Material/Finish	 <small>PG1409</small>	 <small>PG1885</small>	 TTI-IH <small>PG3681</small> IH <small>PG1414</small>	 TTI-YH <small>PG3682</small> YH <small>PG1419</small>	 <small>PG1422</small>
NPT-	Trunking base	Front cover	Internal corner	External corner	Bend, 90°
123 <small>L38950</small> 	NPT-U123 5536011 POW	NPT-F80 5588101 POW	NPT-IH123 5536111 POW Adjustable TTI-IH123 5589170 POW	NPT-YH123 5536211 POW Adjustable TTI-YH123 5589520 POW	NPT-LS1123 5536311 POW

POW = Plastic white RAL 9016,
 PCV = Powder coated white RAL 9016
 POV = Plastic white
 POR = Plastic white RAL 9010,
 PCR = Powder coated white RAL 9010

					
P61413	P61424	P61086	P61428	P61404	P61513
T-piece	Stop end	Joint cover	Wall collar	Cable shelf	Jointing piece
NPT-TS123 5536411 POW	TTI-ES123 5590238 POW 5590237 POR	TTI-US123 5590041 PVC	TTI-CR 123 5594576 POV	TTI-KH272C 5590311	TEK-SSPP 123 5590115

Length material

	Type	Colour	Dimensions A/B/C (mm)	Qty per package	EAN code	Ref. No.
P61409	Trunking base					
	Trunking base with F80 front opening. Can be divided into compartments by means of cable shelves. Material: PC/ABS.					
	NPT-U123	White RAL 9016	123/72/2500	10 m	7315880102533	5536011
P61885	Front cover					
	Front cover, to be snapped into the trunking base. Material: PC/ABS.					
	NPT-F80	White RAL 9016	80/13/2500	20 m	7315880102618	5588101

Corner sections

P61419	External corner, kit					
	External corner kit with F80 front opening. Can be divided into compartments by means of mbkcable shelves. Supplied with front piece. Material: PC/ABS.					
	NPT-YH123	White RAL 9016	123/200/200	1	7315880102557	5536211
P63662	External corner, adjustable, type TTI					
	Open external corner that covers the opening between two trunking lengths installed in an angle to one another. The corner section is made up by two parts which can be moved against one another to create the required angle. Angle adjustment 85–135°. Degree of protection: IP40, provided that the trunking system is mounted direct on the wall. For TTY-IH123, covering plate TTI-BP can be used to reach IP20 when the system is mounted on brackets. Material: PC/ABS.					
	TTI-YH123	White RAL 9016	123/72/145	1	7315885589520	5589520
P61414	Internal corner					
	Internal corner with F80 front opening. Can be divided into compartments by means of cable shelves. Material: PC/ABS.					
	NPT-IH123	White RAL 9016	123/200/200	1	7315880102540	5536111
P63661	Internal corner, adjustable, type TTI					
	Open internal corner that covers the opening between two trunking lengths installed in an angle to one another. The corner section is made up by two parts which can be moved against one another to create the required angle. Angle adjustment 90–135°. Degree of protection: IP40, provided that the trunking system is mounted direct on the wall. For TTI-IH123, covering plate TTI-BP can be used to reach IP20 when the system is mounted on brackets. Material: PC/ABS.					
	TTI-IH123	White RAL 9016	123/72/145	1	7315885589179	5589170

Bends

P61413	T-piece, kit					
	T-piece with F80 front opening. Can be divided into compartments by means of cable shelves. Supplied with front piece. Material: PC/ABS.					
	NPT-TS123	White RAL 9016	200/72/280	1	7315880102571	5536411
P61422	Bend, 90°, kit					
	90° bend, kit, with F80 front opening. Can be divided into compartments by means of cable shelves. Supplied with front piece. Material: PC/ABS.					
	NPT-LS123	White RAL 9016	200/72/200	1	7315880102564	5536311

Wall brackets with accessories type TTA

Type	Colour	Dimensions A/B/C (mm)	Qty per package	EAN code	Ref. No.
------	--------	-----------------------	-----------------	----------	----------

Adjustable wall brackets

Adjustable wall bracket for wall-mounting of trunking. Suitable for use together with ventilation-rib holder kit TTA-GH1 or rib holder TTA-GH6.
Material: Steel, unpainted/Aluminium.

TTA-TN50	Adjustable 50–70	121/67/50	10	7315885583573	5583570
TTA-TN70	Adjustable 70–110	121/67/70	10	7315880095118	5583572
TTA-TN110	Adjustable 110–170	121/67/110	10	7315880095125	5583574
TTA-TN160	Adjustable 160–260	180/67/160	10	7315880095132	5583576

Adjustable wall bracket including loose plastic rib holder TTA-GH1 with steel clamp, for wall-mounting of trunking. The loose rib holder is suitable for ventilation ribs TTA-G10 and TTA-G3.
Material: Steel, unpainted, PC/ABS.

TTA-KVS60A	Adjustable 30–60	77/30/28	10	7315885583603	5583608
------------	------------------	----------	----	---------------	----------------

Fixed wall bracket

Fixed wall bracket for wall-mounting of trunking.
Material: Aluminium, untreated.

TTA-KV15	—	113/23/28	10	7315885583016	5583010
----------	---	-----------	----	---------------	----------------

TTA-KV35	—	130/43/28	10	7315880010241	5583014
----------	---	-----------	----	---------------	----------------

Fixed wall bracket with integrated rib holder

Fixed wall bracket with integrated rib holder, for wall-mounting of trunking. The integrated rib holder is suitable for ventilation rib TTA-G10.
Material: Aluminium, untreated.

TTA-KV35-1	—	130/43/28	10	7315880010258	5583016
TTA-KV56-2	—	130/64/28	10	7315880010265	5583018
TTA-KV79-3	—	130/86/28	10	7315885583023	5583020
TTA-KV101-4	—	132/109/28	10	7315880010272	5583022
TTA-KV123-5	—	132/131/28	10	7315880010289	5583024
TTA-KV146-6	—	130/153/28	10	7315880010296	5583026

Fixed wall bracket with loose rib holder

Fixed wall bracket including loose plastic rib holder TTA-GH1 with steel clamp, for wall-mounting of trunking. The loose rib holder is suitable for ventilation ribs TTA-G10 and TTA-G3.
Material: Aluminium, untreated, PC/ABS.

TTA-KV35	—	132/43/28	10	7315885583030	5583034
TTA-KV56	—	132/64/28	10	7315880029915	5583036
TTA-KV79	—	132/86/28	10	7315880029922	5583038
TTA-KV101	—	132/109/28	10	7315885583047	5583040
TTA-KV123	—	132/131/28	10	7315880029939	5583042
TTA-KV146	—	132/153/28	10	7315880029946	5583044

Ventilation-rib holder

Rib holder to fix ventilation ribs G3 and G10 on the wall brackets. Suitable for TTA-TN, TTA-KV and TTA-KVS.
Material: PC/ABS.

TTA-GH6	Grey	15/120/34	10	7315880030034	5590453
---------	------	-----------	----	---------------	----------------

Ventilation-rib holder, kit

Kit including 10 plastic rib holders and 10 steel clamps, to be used to fix ventilation ribs G3 and G10 on the wall brackets. Suitable for TTA-TN, TTA-KV and TTA-KVS.
Material: PC/ABS (rib holder), steel (clamp).

TTA-GH1	Grey	15/120/34	1	7315880079873	5590456
---------	------	-----------	---	---------------	----------------

P61880



P11390



P13816



P13817



P61384



P61520



P61393







P61520





P61520





Wall brackets with accessories type TTA

Type	Colour	Dimensions A/B/C (mm)	Qty per package	EAN code	Ref. No.	
Ventilation rib						
Ventilation rib to be used together with wall bracket for trunking and ventilation-rib holder. Material: Aluminium, powder coated.						
P61940 	TTA-G3	White RAL 9010	20/3/2500	40	7315880031987	5590482
P61408 	TTA-G10	White RAL 9010	20/10/2500	16	7315880031956	5590424
Joining piece						
Joining piece to be used for jointing of ventilation ribs. Material: Aluminium, untreated.						
P61938 	TTA-GS3	—	9/6/30	10	7315880028956	5590486
P61751 	TTA-GS10	—	13/10/100	8	7315885590441	5590440
Washer						
Washer to be used between bracket and wall or trunking and wall, to compensate for uneven walls. Material: PP.						
P61516 	TTA-KM3	Grey	114/3/38	10	7315885583405	5583408
	TTA-KM5	Grey	114/5/38	10	7315885583412	5583410





Cable shelves type TTI

Double cable shelf						
Double cable shelf to be used to divide the trunking into compartments, for the separation of cables. Material: PC/ABS.						
P61404 	TTI-KH272C	White	64/59/500	20	7315880089377	5590311
	For 72 mm deep trunking					
Cable clip						
Cable clip to be snap-fitted onto the cable shelf, used to retain the cables in their place. Material: PA (TTI-KL52), ABS (TTI-KHK).						
P61936 	TTI-KL52	Black	13/25/40	50	7315880011644	5590346
P61514 	TTI-KHK	Brown	6/43/34	100	7315885590342	5590340
	For TTI-KH72					

Wall frames/collars type TTI

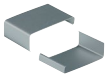
Wall frame						
Wall frame made up by two parts which are assembled and mounted on the trunking by means of two rubber mouldings. The frame has a flange against the trunking. To be used to cover a trunking passage through the wall or to make an attractive finish of the trunking against a wall. Material: ABS.						
P61428 	TTI-CR123	White RAL 9016	193/25/140	1	7315880066637	5594576
Wall collar TTI						
Wall collar made up by two parts that are snapped together. To be used to cover a trunking passage through the wall or to make an attractive finish of the trunking against a wall. Material: ABS.						
P61429 	TTI-R2 123	White RAL 9016	199/8/142	1	7315885590748	5590740

Other accessories type TTI

Type	Colour	Dimensions A/B/C (mm)		Qty per package	EAN code	Ref. No.
Joint cover piece, kit						
Joint cover kits including two joint cover pieces to cover joints between trunking sections. Material: Aluminium, powder coated.						
PE1748		TTI-US123	White RAL 9016	—/45/72	10	7315885590045 5590041
Stop end						
Stop end for snap-fitting on the trunking end. Both for left-hand and right-hand mounting. Material: ABS.						
PE1424		TTI-ES123	White RAL 9010 White RAL 9016	123/—/72	1	7315880011354 7315880102625 5590237 5590238
Cup washer						
Cup washer to cover screw heads inside the trunking in order to protect single-insulated cables. Material: PE.						
PE1037		TTI-KB	Black	Ø13	100	7315885590526 5590520
Jointing piece						
Internal jointing piece to be used when jointing trunking parts. Material: PC/ABS.						
PE1513		TTI-JP123	White	37/67/100	1	7315880022046 5590115

NPT

Technical description

Approvals & standards

Standards	EN 50085
Approvals	SEMKO

Material data NPT

Material	PC/ABS, flame retardant
Resistance to impact	Medium 2 Nm
Colour spec.	<ul style="list-style-type: none"> • White RAL 9010 • White RAL 9016

Material data TTA

Material	Steel
Surface treatment	Galvanized
Colour spec.	Unpainted
Material	Aluminium SS 4104
Colour spec.	<ul style="list-style-type: none"> • Unpainted • White RAL 9010 • Optional acc. to customer choice (use the Ref. No. and add the desired RAL colour and gloss)
Material	PC/ABS (polycarbonate/acrylonitrile-butadiene-styrene)
Colour.	Grey
Material	PP (polypropylene)
Colour	Grey

Material data TTI

Material	PC/ABS (polycarbonate/acrylonitrile-butadiene-styrene)
Fire rating	UL 94 V0
Impact resistance	2 J (medium acc. to EN 50085-1)
Colour	<ul style="list-style-type: none"> • White RAL 9010 • White RAL 9016
Material	ABS (acrylonitrile-butadiene-styrene)
Colour spec.	<ul style="list-style-type: none"> • White RAL 9010 • White RAL 9016 • Brown NCS 8203-Y63R
Material	PE (polyethylene, halogen-free)
Fire rating	UL 94 HB
Chemical resistance	Resistant to lubricants, fuel, refrigerants, enamels and paints, detergents and degreasing agents. Not resistant to acids.
Colours	<ul style="list-style-type: none"> • White • Black
Material	PA (polyamide)
Fire rating	UL 94 V-0
Colour	Black
Material	Aluminium SS 4106
Surface treatment	Powder coating
Colour spec.	<ul style="list-style-type: none"> • White RAL 9010 • White RAL 9016

Operative data

Temperature range	From -25°C to +60°C
Suitable outdoors	No
Degree of protection	IP40

Design and dimensions

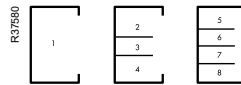
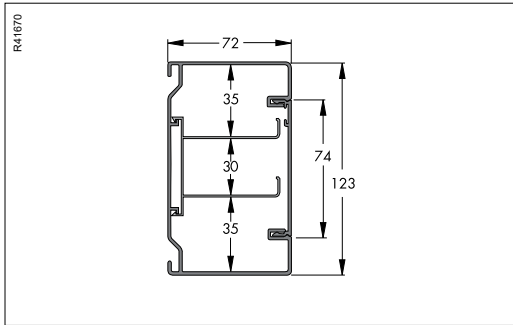

Cable capacity

Comp No	Max Ø mm	Cross section area mm ²	Cable capacity, mm ²		
			40%	50%	60%
Without mounting boxes					
1	55	6449	2580	3225	3869
2	35	1651	660	826	991
3	30	1197	479	599	718
4	35	1604	642	802	962
5	30	1661	664	831	997
6	20	1199	480	600	719
7	20	1199	480	600	719
8	30	1916	766	958	1150

With mounted standard device boxes

1	20	4308	1723	2154	2585
2	20	1258	503	629	755
3	15	576	230	288	346
4	20	1248	499	624	749
5	20	1408	563	704	845
6	15	522	209	261	313
7	15	522	209	261	313
8	20	1497	599	749	898

With mounted CYB boxes, 30 mm deep

1	30	5052	2021	2526	3031
2	25	1447	579	724	868
3	25	876	350	438	526
4	25	1424	570	712	854
5	25	1527	611	764	916
6	20	742	297	371	445
7	20	742	297	371	445
8	25	2078	831	1039	1247

Exploded view

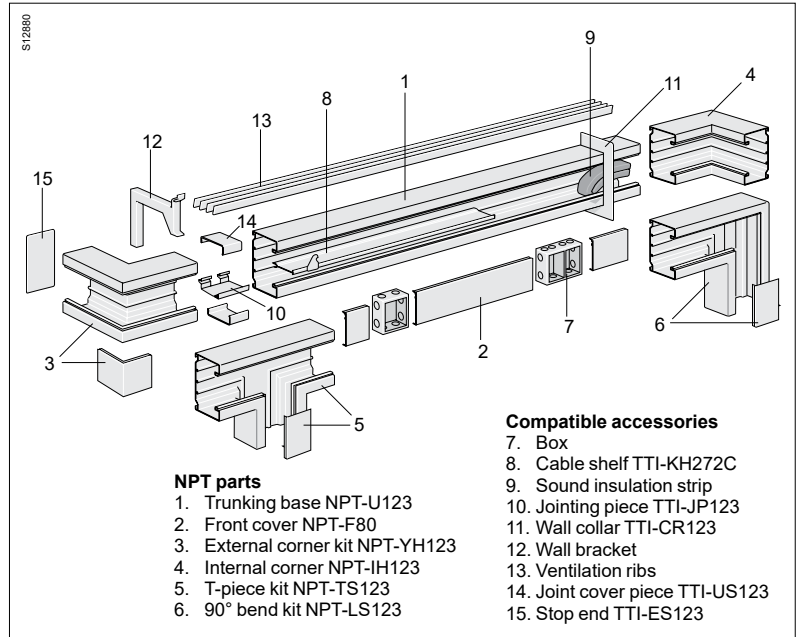

NPT parts

1. Trunking base NPT-U123
2. Front cover NPT-F80
3. External corner kit NPT-YH123
4. Internal corner NPT-IH123
5. T-piece kit NPT-TS123
6. 90° bend kit NPT-LS123

Compatible accessories

7. Box
8. Cable shelf TTI-KH272C
9. Sound insulation strip
10. Jointing piece TTI-JP123
11. Wall collar TTI-CR123
12. Wall bracket
13. Ventilation ribs
14. Joint cover piece TTI-US123
15. Stop end TTI-ES123

Service poles



Description

The Thorsman range of pre-wired and customized service poles POL is a multi purpose system for on-the-spot electrical services for power and communication. The poles are designed to bring power, data and telecommunications directly from the ceiling to the desk, and they are pre-assembled entirely to customer specifications.

The service poles are available in several versions;

- tension-mounted between floor and ceiling
- fixed to cable tray or ladder
- free-standing and movable
- mounted on the wall.

The compatibility with the Thorsman wiring device system CYB allows complete solutions for power and low voltage, telecom and data.

Adjustments to standard outlets on the European market are easily made using MIB boxes.

The service poles are supplied in optional lengths up to 5 metres and in optional colours, pre-wired including cables and plugs, ready to be secured and connected to a so called service gate in the backbone of the building. Each individual pole is tested before delivery and provided with a unique serial number, thus providing possibilities to trace it back in the production line. Test report and wiring diagram follow each pole at delivery.

The poles are specified by means of the PC based planning and specifying aid Combinum.

There is also a number of pre-defined poles that need no specifying.

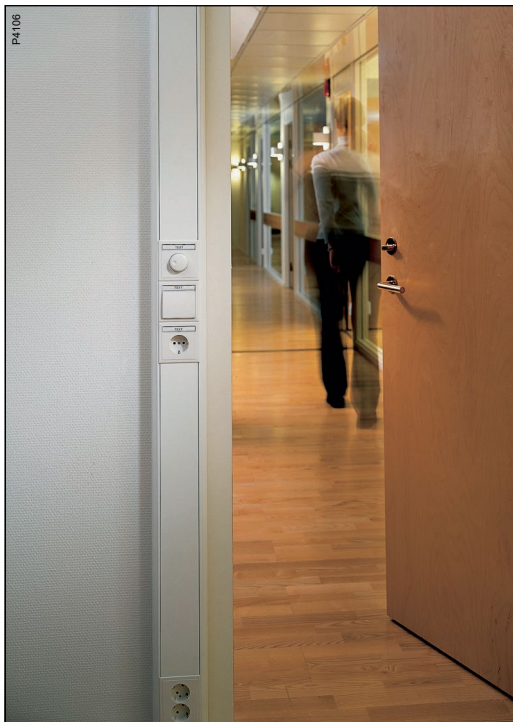

Cable separation

In order to obtain a 25 mm separation between power and low voltage cables the cables in the feeder part of the pole must be run according to the following:

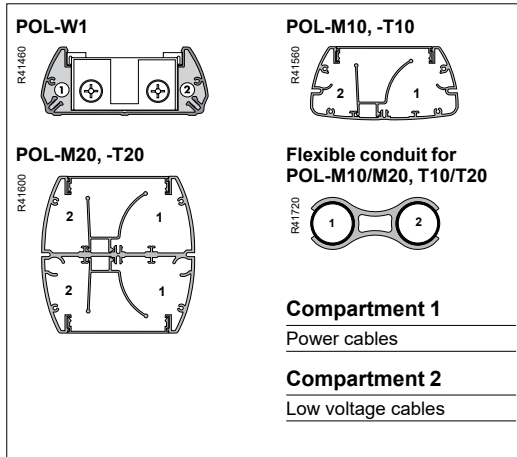

Performance

Electrical data	Rated voltage:	400 V
	Rated current:	16 A
Degree of protection	IP30	
Loads	Maximum horizontal load at the height 1000 mm:	400 N
	Maximum vertical load:	750 N
	Note: Load values applicable to all poles except POL-*M.	

Standards

PrEn 50085-2-4.
SS 424 10 32:1989.

Patents & approvals

Approvals	Please see under each pole type.
Patent & protection of design	<ul style="list-style-type: none"> • Foot ISM20809: protection of design granted in EC countries. • Base profile for POL-M10, -M20, -T10, -T20: protection of design granted in Sweden, Finland, Denmark, Norway, Germany, Holland, Belgium and Luxemburg.

Material data

Aluminium	Specification	SS 4104, BS H9, DIN Al Si 0.5
Cast iron	Surface treatment	<ul style="list-style-type: none"> • Coated with clear varnish (POL-FM1) • Dip coated (POL-FM2)
	Other info	Lubricated
Steel 1142	Specification	SS 1142
Steel 1411	Specification	SS 1411
Steel spring 1774-05	Specification	SS 1774-05
	Surface treatment	Lubricated
Steel tubing 2394	Specification	DIN 2394
Rubber	Specification	EPDM
	Other info	Halogen-free
PA 6 (polyamide)	Other info	Halogen-free
PP (polypropylene)	Other info	Halogen-free
Polystyrene	Other info	Halogen-free
PVC		
PC/ABS		

Surface treatment

Anodizing	5–10 µm, natural
Powder coating	Epoxy-polyester mix or polyester, 50–100 µm

Colours and surface coatings

Service poles	Natural anodized or powder coated according to Thorsman Colour Choice.	
Front covers	Natural anodized or powder coated according to Thorsman Colour Choice. Lengths available for delivery: Maximum 2500 mm.	
Accessories	If nothing else is stated the following applies:	
	White	= RAL 9016
	Grey	= RAL 9007
	White textured	= KP 546-9216 ≈ RAL 9010
	Black textured	= KP 545-7069 ≈ RAL 9011

Operative data

Suitable outdoors	No
Degree of protection	IP30
Electrical data	230/400V, 16 A

Classification acc. to PrEn 50085

Material	6.1.1 Metallic
Impact resistance	6.2.3 Medium impact
Temperature	6.3 Code 221 (= min. storage and transport temperature -25°C, min. installation and application temperature -15°C, max. application temperature +60°C)

Customized and pre-wired service poles

Type	Dimensions A/B/C (mm)	EAN code	Ref. No.
------	--------------------------	----------	----------

Customized and pre-wired service poles for installation of power and communication from the ceiling. To be specified in Combinum. All poles are CE-marked according to the Low Voltage Directive (LVD).
Material: Aluminium (profiles, front cover).

Tension-mounted between floor and ceiling, or fixed to cable tray/ladder

Service poles to be tension-mounted between floor and ceiling or fixed to cable tray or ladder in the ceiling. Including floor fixing and all necessary accessories to fix the pole to the ceiling.

POL-T10 Wiring devices can be placed along the whole length of the pole.	Max. 5000/61/120	—	GCR_CMS9330
POL-T20 Wiring devices can be placed along the whole length of the pole.	Max. 5000/12940/117	—	GCR_CMS9331

L63260
L63290

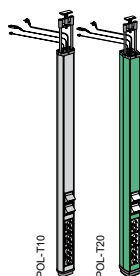

Free-standing and movable

Free-standing and movable service pole. When using flexible conduit POL-FS in combination with foot ISM20808 or ISM20809, the pole can be moved within a radius ranging up to 1500 mm from the connection point in the ceiling. Due to its heavy weight the foot is supplied under separate packing.

POL-M10	*/61/120 *) Maximum length 5000 mm (profile = max. 3000 mm, flexible conduit = max. 2000 mm)	—	GCR_CMS9332
POL-M20	*/120/117 *) Maximum length 5000 mm (profile = max. 3000 mm, flexible conduit = max. 2000 mm)	—	GCR_CMS9333

L63260
L63270

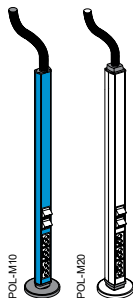

Wall-mounted



Service pole intended for wall mounting.

POL-W1 Wiring devices can be placed along the whole length of the pole, except above fastening screws.	Max. 5000/49/115	—	GCR_CMS9308
--	------------------	---	--------------------

L61380

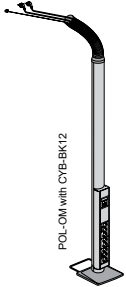

Pre-defined and pre-wired service poles

Type	Dimensions A/B/C (mm)		EAN code	Ref. No.	
Free-standing and movable					
 <p>P87852</p>	<p>Pre-wired, free-standing and movable service pole, unearthed. Equipped with access and outlet system type Thorsman CYB including connection cables and plugs. Foot to be ordered separately. Pole length: 2173 mm + flexible conduit 2000. Box height: 590 mm. Each box includes: <ul style="list-style-type: none"> • Schuko 250V/16A: two triple master outlets, one of which is marked DATA, and one double slave outlet. • Communication outlets, see below. The triple master outlets and the communication outlets are provided with label windows for easy marking. Free cable lengths outside the flexible conduit: pair cable 6200 mm, 250V cable 2000 mm. Material: Aluminium.</p>				
	<p>POL-OM With 1 x CYB-BK12 including 2 x Actassi Cat. 6 + 2 x blank plate in each box</p>	White	2173+2000/89/100	1	7315880111153
Free-standing and movable, mounted on a foot					
 <p>P81196</p>	<p>Pre-wired, two-sided, free-standing service pole mounted on a foot. Unearthed. Equipped with Thorsman access and outlet system type CYB including connection cable and plug/modular plug. NOTE! Foot POL-FM to be ordered separately. Including, on each side: <ul style="list-style-type: none"> • Schuko 250V/16A: two triple master outlets, one of which is marked DATA, and one double slave outlet. • Communication outlets, see below. The triple master outlets and the communication outlets are provided with label windows for easy marking. Free cable lengths: pair cable 6400 mm, 250V cable 2100 mm. Material: Aluminium.</p>				
	<p>POL-M20 With 1 x CYB-BK12 including 2 x Actassi Cat. 6 + 2 x blank plate on each side</p>	White	2150+2000/120/117	1	7315880113065
Tension-mounted between floor and ceiling					
 <p>P83136</p>	<p>Pre-wired service pole, for tension-mounting between floor and ceiling. Unearthed. Equipped with Thorsman access and outlet system type CYB including connection cable and plug/modular plug. Including: <ul style="list-style-type: none"> • Schuko 250V/16A: two triple master outlets, one of which is marked DATA, and one double slave outlet. • Communication outlets, see below. The triple master outlets and the communication outlets are provided with label windows for easy marking. Free cable lengths: Pair cable 7700 mm, 250V cable 3400 mm. Material: Aluminium.</p>				
	<p>POL-T10 With 1 x CYB-BK12 including 2 x Actassi Cat. 6 + 2 x blank plate</p>	White	2870–3270/61/120	1	7315880112907

Pre-defined and pre-wired service poles

Type	Colour	Dimensions A/B/C (mm)	Qty per package	EAN code	Ref. No.
------	--------	--------------------------	--------------------	----------	----------

Tension-mounted between floor and ceiling

Pre-wired, two-sided service pole for tension-mounting between floor and ceiling. Unearthed. Equipped with Thorsman access and outlet system type CYB including connection cable and plug/modular plug.

Including, on each side:

- Schuko 250V/16A: two triple master outlets, one of which is marked DATA, and one double slave outlet.
- Communication outlets, see below.

The triple master outlets and the communication outlets are provided with label windows for easy marking.

Free cable lengths: Pair cable 7700 mm, 250V cable 3400 mm.

Material: Aluminium.

POL-T20	White	2870–3270/120/117	1	7315880112938	5863681
----------------	-------	-------------------	---	---------------	----------------

With 1 x CYB-BK12 including 2 x Actassi Cat. 6 + 2 x blank plate on each side

P81197

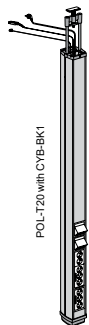

Empty service poles

Tension-mounted between floor and ceiling

Empty service pole for tension-mounting between floor and ceiling. Unearthed. Supplied without wiring devices and cables.

Material: Aluminium.

POL-T10	White	3170–3570/61/120	1	7315885863576	5863572
----------------	-------	------------------	---	---------------	----------------

One-sided	Anodized			7315880105404	5863573
-----------	----------	--	--	---------------	----------------

POL-T10	White	2870–3270/61/120	1	7315880100737	5863502
----------------	-------	------------------	---	---------------	----------------

One-sided	Anodized			7315880105411	5863503
-----------	----------	--	--	---------------	----------------

POL-T10	White	2670–3070/61/120	1	7315885863552	5863552
----------------	-------	------------------	---	---------------	----------------

One-sided	Anodized			7315880105428	5863554
-----------	----------	--	--	---------------	----------------

L65890



P83564



Empty service pole for tension-mounting between floor and ceiling. With one installation box for wiring devices, accessible front opening 700 mm. Adjustability of ceiling fixing 400 mm. Unearthed. Supplied without wiring devices and cables.

Material: Aluminium.

POL-O	Anodized	3400–3800/89/100	1	7332418018289	5867320
--------------	----------	------------------	---	---------------	----------------

With one box

Empty service poles

Type	Colour	Dimensions A/B/C (mm)	Qty per package	EAN code	Ref. No.
------	--------	--------------------------	--------------------	----------	----------

Free-standing and movable

Empty, free-standing and movable service pole. Unearthed. Supplied without wiring devices and cables. Foot to be ordered separately.
Material: Aluminium.

POL-OM	Anodized	2465+2000/89/100	1	7315885863057	5863050
---------------	----------	------------------	---	---------------	----------------

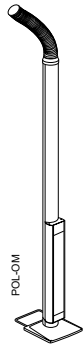

P80504

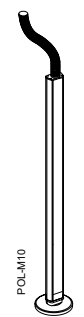

P80507
P80508

Empty, free-standing and movable service pole. Unearthed. Supplied without wiring devices and cables. Foot to be ordered separately.
Material: Aluminium.

POL-M10 One-sided	Anodized	2415+2000/61/120	1	7315880112983	5863744
-----------------------------	----------	------------------	---	---------------	----------------

Accessories for POL-O

Type	Colour	Dimensions A/B/C (mm)	Qty per package	EAN code	Ref. No.
Floor fixing plate					
Fixing plate to fix tension-mounted poles to the floor by screws. Fixed to the pole by pegs. From the OptiLine range. Material: Steel, electroplated.					
Floor fixing plate	—	13/49/60	1	3606480567438	ISM20828

Accessories for POL-OM

Ceiling frame					
Ceiling frame intended to lead flexible conduit Ø55 mm through false ceiling. To be mounted in circular hole, Ø125 mm, by using three included clamps. Also including a slotted plastic plate to be used to lock the flexible conduit, which is fixed by cable ties. The plate can also be used as a drill template for entrance hole Ø125 mm. From the OptiLine range. Material: PC/ABS.					
Ceiling frame	Polar white RAL 9003	89/Ø161	1	3606480682216	ISM20812P

Ceiling fixing					
Ceiling fixing intended to connect flexible conduit Ø55 mm to ceiling or wall. Fixings not included. From the OptiLine range. Material: Aluminium, powder coated.					
Ceiling fixing	White RAL 9010	50/156/90	1	3606480030666	ISM20816

Cable tray fixing					
Cable tray fixing including fixing material, intended to connect flexible conduit Ø55 mm to cable tray/mesh tray. Gripping around the tray. From the OptiLine range. Material: Steel, powder coated.					
Cable tray fixing	White RAL 9010	100/15/70	1	3606480030635	ISM20813

Busbar fixing					
Busbar fixing for Ø55 mm flexible conduits, intended to connect the conduit to busbar trunking. From the OptiLine range. Material: Steel, powder coated.					
Busbar fixing	White RAL 9010	105/90/70	1	3606480030659	ISM20815

Foot					
Round foot for free-standing, movable poles, to be fixed to the bottom plate of the pole by means of two M6 bolts (included). Suitable both for one and two-sided poles. From the OptiLine range. Material: Cast iron, painted.					
Foot, round	Grey	29/Ø317	1	3606480030581	ISM20808

Rectangular foot for free-standing, movable pole, to be fixed to the bottom plate of the pole by means of two M6 bolts (included). The foot is provided with a steel clamp that can be unfolded for extra support. When not in use, the clamp lies protected in a recess underneath the foot. Specially suited in applications close to the wall or when two poles are positioned back to back. From the OptiLine range. Material: Cast iron, painted.					
Foot, rectangular	Grey	33/250/346	1	3606480030598	ISM20809

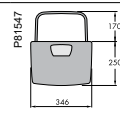

Components and accessories for POL-M10/M20 and POL-T10/T20

Type	Colour	Dimensions A/B/C (mm)		Qty per package	EAN code	Ref. No.
Cable tray fixing						
Cable tray fixing including fixing material, intended to connect flexible conduit Ø55 mm to cable tray/mesh tray. Gripping around the tray. From the OptiLine range. Material: Steel, powder coated.						
Cable tray fixing	White RAL 9010	100/15/70		1	3606480030635	ISM20813
Busbar fixing						
Busbar fixing for Ø55 mm flexible conduits, intended to connect the conduit to busbar trunking. From the OptiLine range. Material: Steel, powder coated.						
Busbar fixing	White RAL 9010	105/90/70		1	3606480030659	ISM20815
Floor fixing plate						
Fixing plate to fix tension-mounted poles to the floor by screws. Fixed to the pole by pegs. From the OptiLine range. Material: Steel, electroplated.						
Floor fixing plate	—	13/49/60		1	3606480567438	ISM20828
Foot						
Round foot for free-standing, movable poles, to be fixed to the bottom plate of the pole by means of two M6 bolts (included). Suitable both for one and two-sided poles. From the OptiLine range. Material: Cast iron, painted.						
Foot, round	Grey	29/Ø317		1	3606480030581	ISM20808
Rectangular foot for free-standing, movable pole, to be fixed to the bottom plate of the pole by means of two M6 bolts (included). The foot is provided with a steel clamp that can be unfolded for extra support. When not in use, the clamp lies protected in a recess underneath the foot. Specially suited in applications close to the wall or when two poles are positioned back to back. From the OptiLine range. Material: Cast iron, painted.						
Foot, rectangular	Grey	33/250/346		1	3606480030598	ISM20809
Ceiling fixing						
Ceiling fixing intended to connect flexible conduit Ø55 mm to ceiling or wall. Fixings not included. From the OptiLine range. Material: Aluminium, powder coated.						
Ceiling fixing	White RAL 9010	50/156/90		1	3606480030666	ISM20816
Ceiling frame						
Ceiling frame for base profile for POL-M10/T10 and POL-M20/T20 respectively. Covers the edge of the hole in a false ceiling. Self-sticking. Only for tension-mounted poles. Material: Polystyrene.						
POL-CF2 For POL-M10/T10	White	1/111/170		1	7315885865259	5865250
Ceiling frame intended to lead flexible conduit Ø55 mm through false ceiling. To be mounted in circular hole, Ø125 mm, by using three included clamps. Also including a slotted plastic plate to be used to lock the flexible conduit, which is fixed by cable ties. The plate can also be used as a drill template for entrance hole Ø125 mm. From the OptiLine range. Material: PC/ABS.						
Ceiling frame	Polar white RAL 9003	89/Ø161		1	3606480682216	ISM20812P

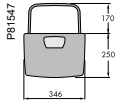

Accessories for POL-OW

Type	Colour	Dimensions A/B/C (mm)	Qty per package	EAN code	Ref. No.
Ceiling fixing					
Ceiling fixing intended to connect flexible conduit Ø55 mm to ceiling or wall. Fixings not included. From the OptiLine range. Material: Aluminium, powder coated.					
P86528	White RAL 9010	50/156/90	1	3606480030666	ISM20816

Components and accessories for POL-W1

Base profile for wall mounting					
Base profile, length 2700 mm. Punched holes in the back to simplify mounting. With internal screw rail for earth connection. To be used with wiring devices type CYB or CAN, or, for devices with a c/c 60 distance, with installation box type MIB. Material: Aluminium, natural anodized or powder coated.					
P85088	White	2700/49/115	2	7315880079712	5860101

Stop end					
Stop end intended to shut the lower end of base profile POL-W1. Material: Aluminium.					
P81610	White	14/49/115	1	7315885865433	5865430

Ceiling frame					
Ceiling frame intended for use when POL-W1 is led through a false ceiling, to cover the edges of the hole. Material: Polystyrene.					
P81612	White	1/74/160	1	7315885865242	5865240

Cable holder					
Cable holder to divide the base profile POL-W1 into three compartments. To be snap-fitted into the base profile. Material: PC/ABS.					
P85088	Greyish-black	30/17/88	10	7315880079774	5871105

Cable retainer					
Clamp intended to hold cables in place in POL-W1. Material: PA.					
P82583	Black	12/42/14	10	7315880079668	5401615

Other accessories

P85100



Type	Colour	Dimensions A/B/C (mm)	 Qty per package	EAN code	Ref. No.
Partition profile					
Partition profile of halogen-free material with two partition walls. Mounted in internal fixing rails of base profiles. Material: ABS.					
TTP-PP	White	500/49/50	25	7315885871038	5871030

POL-O

Design and dimensions

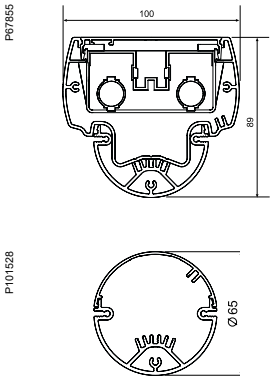

Technical drawings of POL-O service pole showing front and top views with dimensions. The front view shows a width of 100 mm and a height of 89 mm. The top view shows a diameter of 65 mm. Part numbers P07855 and P101528 are indicated.

Length options, mm	With ceiling fixing: 2200-2600, 2600-3000, 3000-3400 or 3400-3800 Without ceiling fixing: 2020, 2420, 2820, 3220
Installation box height	Standard height 590 or 700 mm Optional free heights 100-1000 mm
Approvals	SEMKO, FIMKO, NEMKO

Exploded view

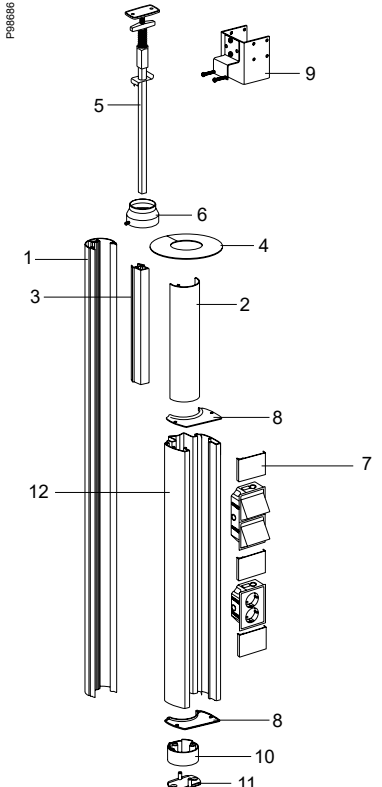

Exploded view diagram of POL-O service pole with numbered components (1-12).

1. Base profile
2. Cover
3. Guide profile for ceiling fixing
4. Ceiling frame POL-CF6
5. Ceiling fixing
6. Adaptor POL-AF1
7. Front cover
8. Stop end
9. Cable tray fixing
10. Floor fixing
11. Fixing plate
12. Service box profile

POL-OM

Design and dimensions

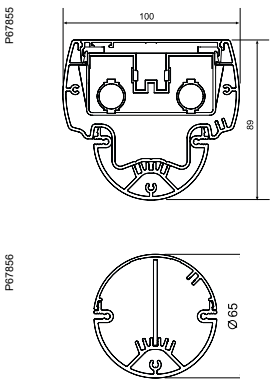

Technical drawings of POL-OM service pole showing front and top views with dimensions. The front view shows a width of 100 mm and a height of 89 mm. The top view shows a diameter of 65 mm. Part numbers P07855 and P07856 are indicated.

Length options, mm	2165, 2465 or 2915
Installation box height	Standard height 590 or 700 mm Optional free heights 100-1000 mm
Approvals	SEMKO, FIMKO, NEMKO

Exploded view

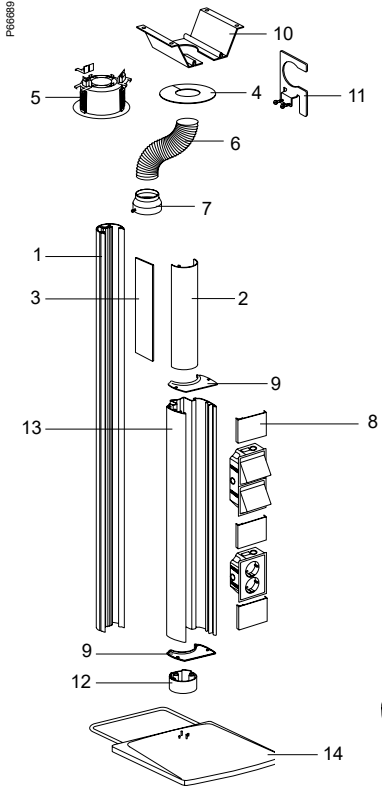

Exploded view diagram of POL-OM service pole with numbered components (1-15).

1. Base profile
2. Cover
3. Separation wall
4. Ceiling frame POL-CF6
5. Ceiling frame ISM20812P
6. Flexible conduit Ø55 mm
7. Adaptor POL-AF1 for flexible conduit
8. Front cover
9. Stop end
10. Ceiling fixing ISM20816
11. Cable tray fixing ISM20813 or busbar fixing ISM20815
12. Floor fixing
13. Service box profile
14. Foot ISM20809
15. Foot ISM20808

POL-OW

Design and dimensions

Maximum length	5 m
Length of flexible conduit	From 300 to 2000 mm
Installation box height	Standard height 590 or 700 mm Optional free heights 100–1000 mm
Approvals	SEMKO, FIMKO, NEMKO

Exploded view

1. Base profile, back
2. Cover
3. Separation wall
4. Ceiling frame POL-CF7
5. Flexible conduit Ø55 mm
6. Adaptor POL-AF1 for flexible conduit
7. Ceiling fixing ISM20816
8. Front cover
9. Stop end
10. Wall bracket, angled
11. Wall bracket POL-VF2
12. Service box profile

POL-M10/M20

Design and dimensions

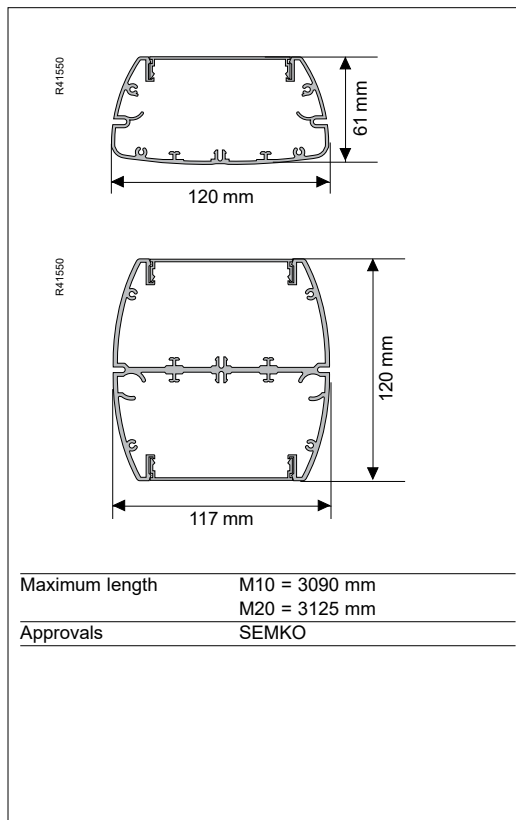

Exploded view

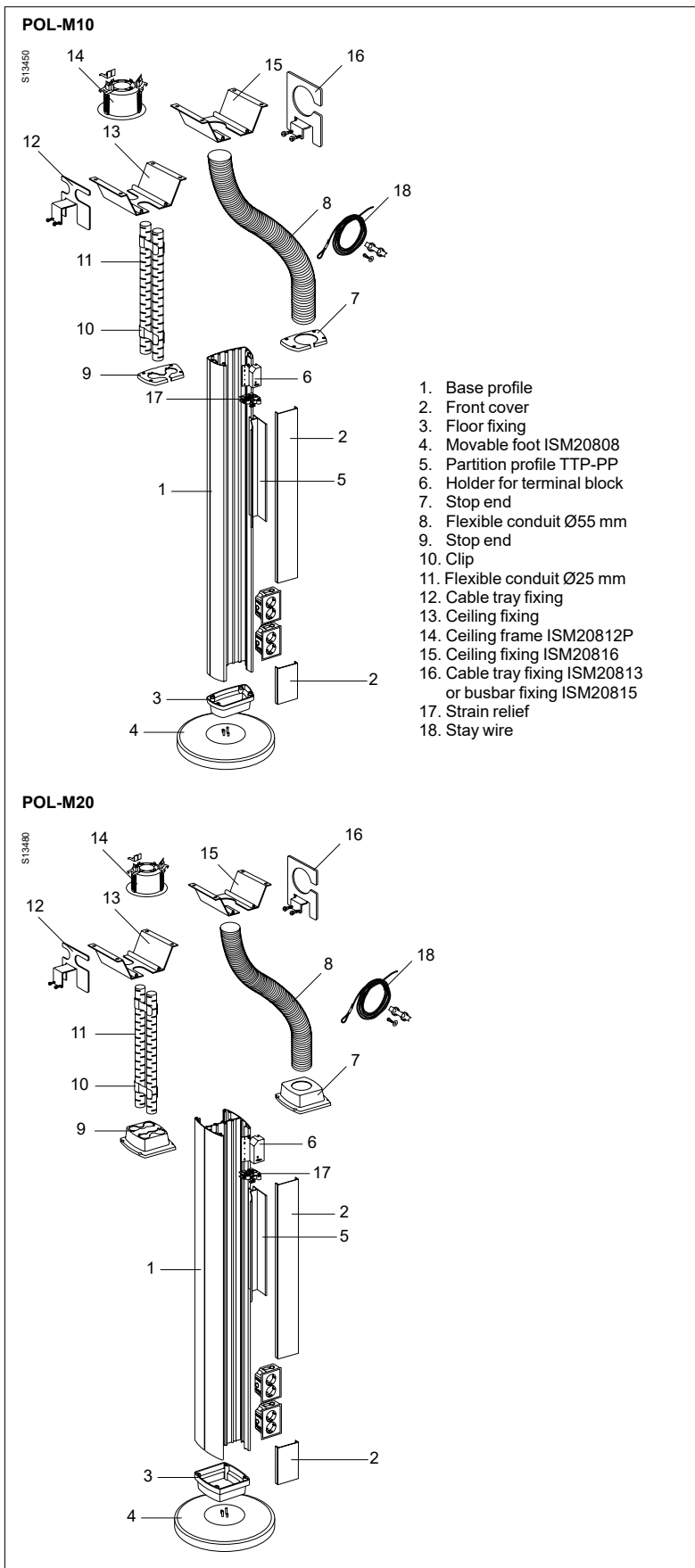

POL-T10/T20

Design and dimensions

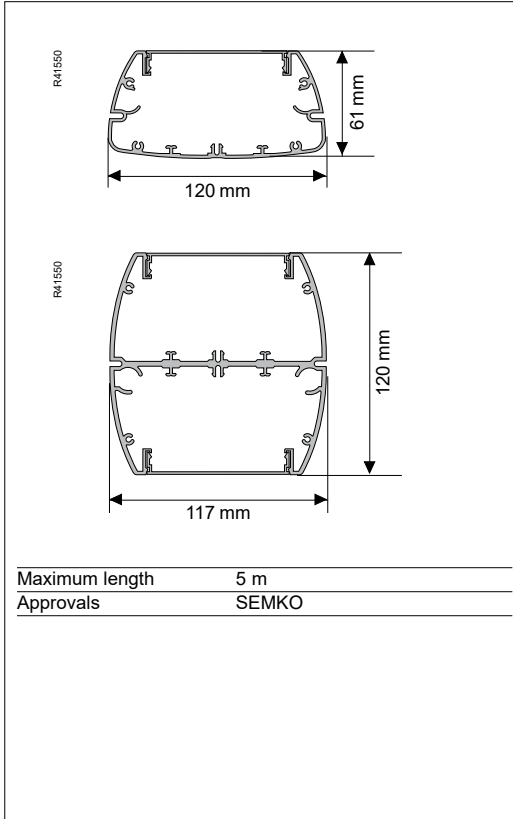

Exploded view

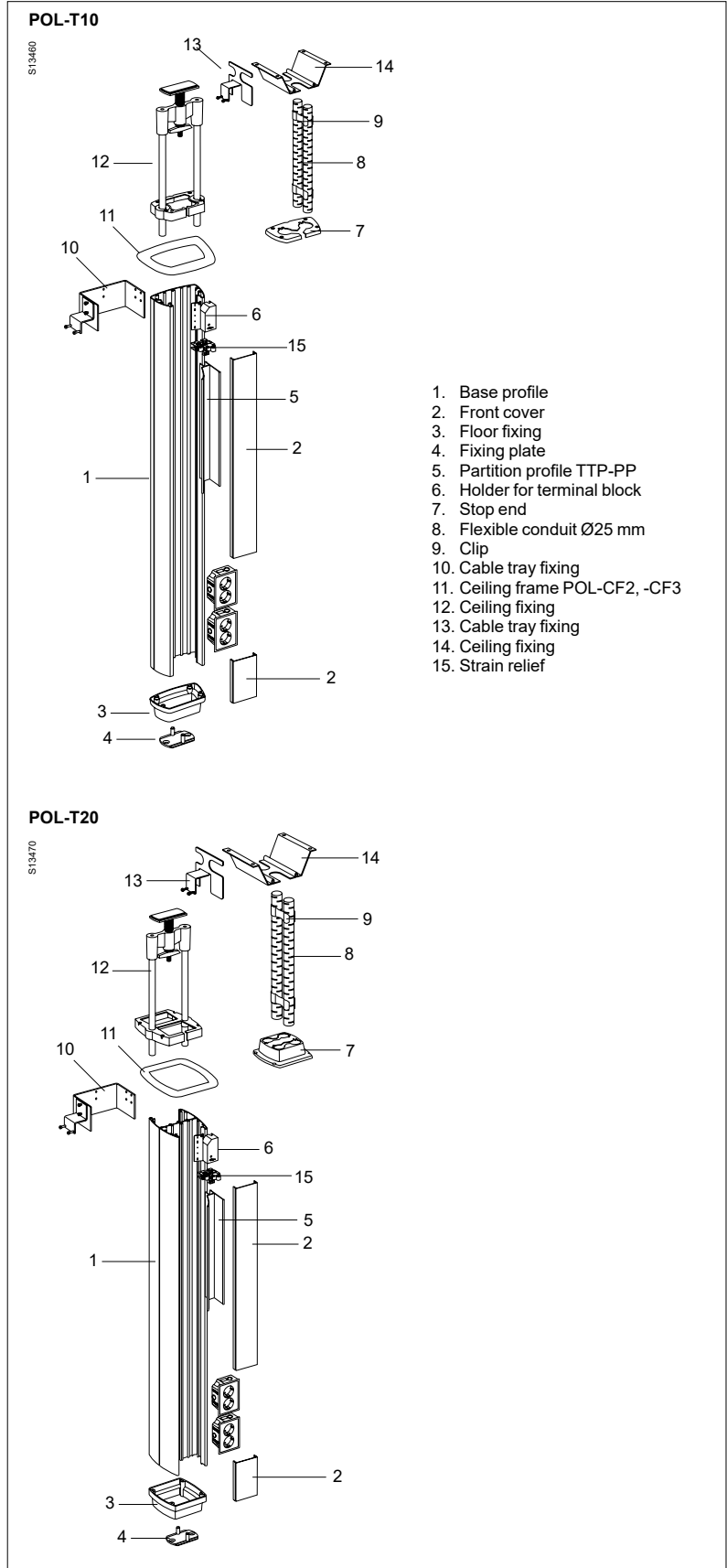

POL-W1

Design and dimensions

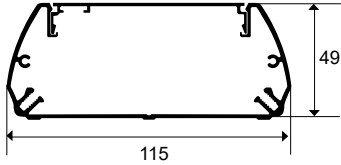

R41260

115

49

Maximum length	5 m
Approvals	SEMKO

Exploded view

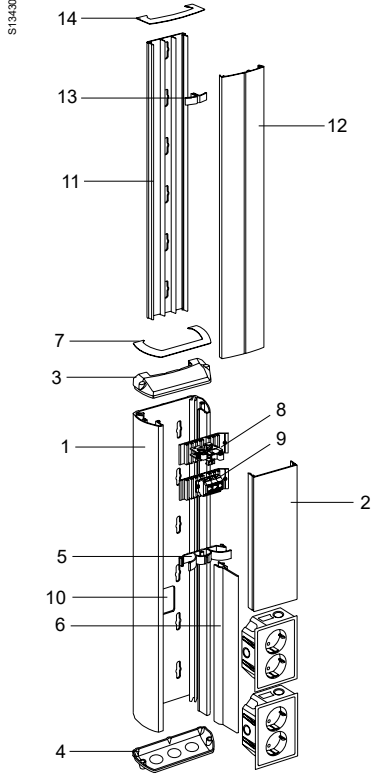

S13430

14

13

11

7

3

1

5

10

6

4

12

8

9

2

Service pole items

1. Base profile POL-W1
2. Front cover
3. Collar POL-CR1
4. Stop end POL-ES1
5. Cable holder TTP-CH2
6. Cable shelf TTI-KH42
7. Ceiling frame POL-CF1
8. Strain relief
9. Terminal block
10. Hole for incoming cables (optional)

Feeder part items

11. Feeder profile, base part
12. Feeder profile, cover
13. Cable holder TTI-KH42
14. Ceiling frame

Cable capacity

Comp.	Max Ø mm	Cross section area mm ²	Cable capacity*) mm ²		
			40%	50%	60%
POL-T10, -M10					
1	49	5303	2121	2651	3182
With partition profile					
1	23	1210	484	605	726
2	31	1877	751	938	1126
3	36	1971	788	985	1182
With CAN, MIB and CYB boxes, 44 mm deep (external measure)					
1	16	2090	836	1045	1254
Ceiling fixing					
1	46	3279	1311	1639	1967
Flexible conduit					
1 (2x)	23	415	166	208	249
POL-O, -OM, -OW					
1	40	1793	717	896	1076
2	22	870	348	435	522
3	20	840	336	420	504
With CAN, MIB and CYB boxes, 44 mm deep (external measure)					
1	22	1856	724	928	1114
With CYB boxes, 32 mm deep (external measure)					
1	33	2614	1046	1307	1568
Flexible conduit Ø25					
1	23	415	166	208	249
Flexible conduit Ø20					
1	18	254	102	127	152

Comp.	Max Ø mm	Cross section area mm ²	Cable capacity*) mm ²		
			40%	50%	60%
POL-T20, -M20					
1	50	5622	2249	2811	3373
2	50	5320	2128	2660	3192
With partition profile					
1	32	1374	550	687	824
2	30	1735	694	867	1041
3	41	2187	875	1093	1312
4	29	1220	488	610	732
5	30	1735	694	867	1041
6	39	2033	813	1016	1220
With CAN, MIB and CYB boxes, 44 mm deep (external measure)					
1	21	2439	975	1219	1463
2	17	2131	852	1065	1278
Ceiling fixing (POL-T20)					
1 (2x)	46	7096	2838	3548	4257
Flexible conduit					
1 (2x)	23	415	166	208	249
POL-W1					
1	44	4283	1713	2141	2570
With cable holder TTP-CH2					
1, 3	22	160	64	80	96
2	25	288	115	144	173
4	20	103	41	52	62
With cable holder TTP-CH2 and cable shelf TTI-KH42					
1, 3	22	160	64	80	96
2	25	125	50	63	75
4	18	172	69	86	103
5	8	126	50	63	76
With CAN, MIB and CYB boxes, 44 mm deep (external measure)					
1, 2	12	519	151	314	376
With CYB boxes, 32 mm deep (external measure)					
1	13	2037	815	1018	1222

*) We recommend a 40% utilization of the cable capacity.

Cross section area, mm²

Round cable Ø mm	Number of cables									
	1	2	3	4	5	6	7	8	9	10
3	7.1	14.2	21.3	28.4	35.5	42.6	49.7	56.8	63.9	71.0
4	12.6	25.2	37.8	50.4	63.0	75.6	88.2	101	113	126
5	19.6	39.2	58.8	78.4	98.0	118	137	157	176	196
6	28.3	56.6	84.9	113	142	170	198	226	255	283
7	38.5	77.0	116	154	193	231	270	308	347	385
8	50.0	100	150	200	250	300	350	400	450	500
9	63.7	127	191	255	319	382	446	510	573	637
10	78.5	157	236	314	393	471	550	628	707	785
11	95	190	285	380	476	570	665	760	855	950
12	113	226	339	452	565	678	791	904	1017	1130
13	133	266	399	532	665	798	931	1064	1197	1330
14	154	308	462	616	770	924	1078	1232	1386	1540
15	177	354	531	708	885	1062	1239	1416	1593	1770
16	201	402	603	804	1005	1206	1407	1608	1809	2010
17	227	454	681	908	1135	1362	1589	1816	2043	2270
18	255	510	765	1020	1275	1530	1785	2040	2295	2550
19	284	568	852	1136	1420	1704	1988	2272	2556	2840
20	315	630	945	1260	1575	1890	2205	2520	2835	3150
Oval cable mm										
2 x 3	5.2	10.4	15.6	20.8	26	31.2	36.4	41.6	46.8	52
2 x 5	9.2	18.4	27.6	36.8	46	55.2	64.4	73.6	82.8	92
3 x 6	16.1	32.2	48.3	64.4	80.5	96.6	112.7	128.8	144.9	161
4 x 7	24.6	49.2	73.8	98.4	123	147.6	172.2	196.8	221.4	246

Service posts



Description

The service posts type Thorsman POS have been designed to handle the supply of power and communication cables for modern, flexible office solutions.

They offer large capacity on a minimal floor-area, with easy access to the service content, which is of Thorsman CYB type.

The posts are supplied pre-wired, specified in the pre-wired systems configurator Combinum. Each pre-wired and factory-produced service post is supplied with a unique serial number, to facilitate identification, additional orders, etc.

There is also a number of pre-defined standard posts available for fast delivery.

POS-F10/F20

POS-F10 is a slim one-sided post and POS-F20 a two-sided post for enhanced capacity. Both posts have longitudinal screw slots that can be provided with decorative strips.

Design & dimensions

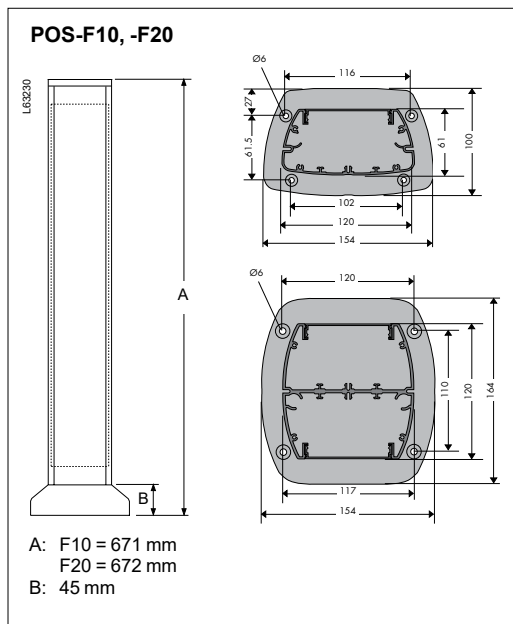

Customized, pre-wired service posts

P80833
P80508



Type	Colour	Dimensions ABC (mm)	Qty per package	EAN code	Ref. No.
------	--------	------------------------	--------------------	----------	----------

Customized and pre-wired service posts for installations of power and communication from the floor. Specification is made in Combinum. Suitable for open-plan offices, shops, exhibition halls, etc. All posts are CE-marked according to the Low Voltage Directive (LVD). Material: Aluminium (profiles, front covers).

POS-F10, POS-F20

POS-F10 One-sided post	Optional	671/100/154	1	—	GCR_CMS9338
POS-F20 Two-sided post	Optional	672/164/154	1	—	GCR_CMS9339

Pre-defined, pre-wired service posts

F72854



One-sided post

Pre-wired service post mounted on a foot, one-sided or two-sided. Unearthed. Equipped with access and outlet system type Thorsman CYB including connection cable and plug/modular plug.

Including, on each side:

- Schuko 250V/16A: two triple master outlets, one of which is marked DATA, and one double slave outlet.
- Communication outlets, see below.

The triple master outlets and the communication outlets are provided with label windows for easy marking.

External cables: two unshielded 3x1.5 mm² with side-earthed plug, 2.7 m free length, and two Cat. 6 UTP data cables with RJ45 plugs, 9.5 m free length.

Material: Aluminium.

POS-F10 With 1 x CYB-BK12 including 2 x Actassi Cat. 6 UTP and 2 x blank plate	White	671/100/154	1	7315880113225	5868326
--	-------	-------------	---	---------------	----------------

Empty service posts

F72850



Empty, free-standing service post mounted on a foot. Including aluminium front cover, stop end part and mounting instructions. Also including gasket ring. Unearthed. Supplied without service content and cables.

Material: Aluminium.

POS-F10 One-sided	Anodized White RAL 9010	671/100/154	1	7315885868328 7315880103103	5868320 5868321
POS-F20 Two-sided	Anodized White RAL 9010	672/164/154	1	7315885868427 7315880102939	5868420 5868421

Accessories

P85101





Floor fixings

Floor fixing for POS-F10 and F20 respectively. Fixed to the floor by screws. Provided with gasket ring.

Material: Aluminium, powder coated.

POS-FT10	Grey	45/154/100	1	7315880096795	5870241
----------	------	------------	---	---------------	----------------

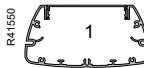
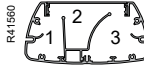
Cable capacity

Comp.	Max Ø mm	Cross section area mm ²	Cable capacity mm ²		
			40%	50%	60%
POS-F10					
					
1	49	5303	2121	2651	3182
With partition profile					
					
1	23	1210	484	605	726
2	31	1877	751	938	1126
3	36	1971	788	985	1182
With CAN, MIB and CYB boxes, 44 mm deep (external measure)					
1	16	2090	836	1045	1254
POS-F20					
					
1	50	5622	2249	2811	3373
2	50	5320	2128	2660	3192
With partition profile					
					
1	32	1374	550	687	824
2	30	1735	694	867	1041
3	41	2187	875	1093	1312
4	29	1220	488	610	732
5	30	1735	694	867	1041
6	39	2033	813	1016	1220
With CAN, MIB and CYB boxes, 44 mm deep (external measure)					
1	21	2439	975	1219	1463
2	17	2131	852	1065	1278

Exploded views

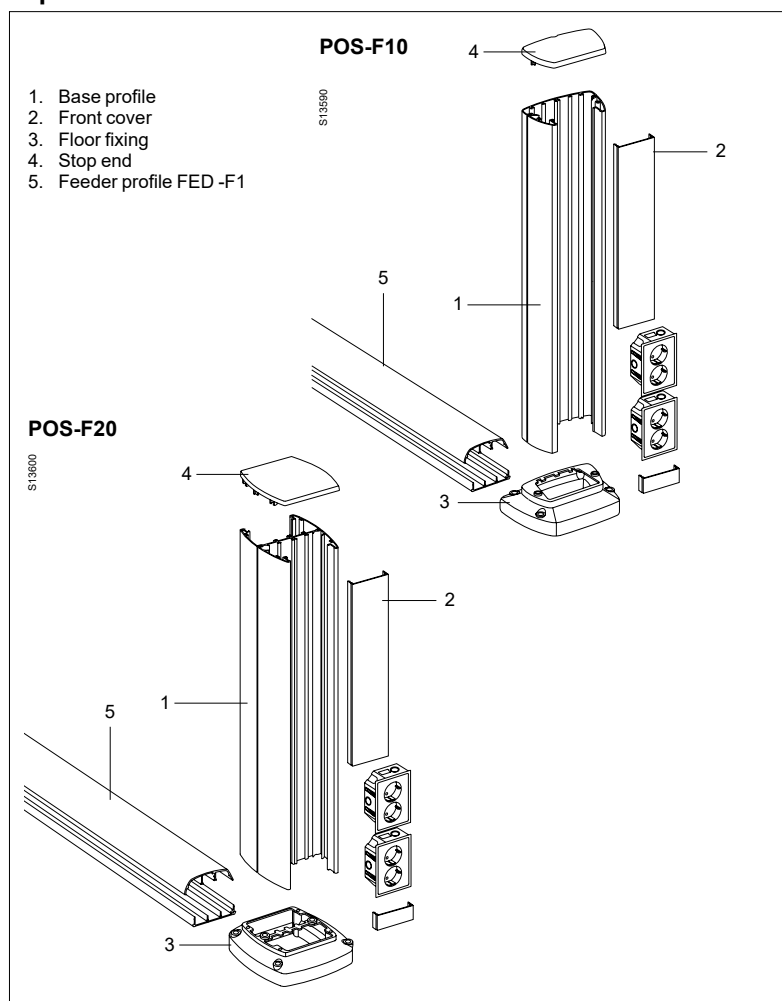

Standards & approvals

Standard	SS 424 10 32
Approval	SEMKO
	VDE pending.

Material data POS-F10 and -F20

Base profile, front cover, floor fixing, stop end	Material	Aluminium SS 4104
	Surface treatment	Anodizing or powder coating
	Colour spec.	<ul style="list-style-type: none"> • Natural anodizing • White RAL 9016 (Except empty posts, which are white RAL 9010)
Foot	Material	Cast iron
	Surface treatment	Coated with clear varnish

Operative data

Temperature range	From -15°C to +60°C
Suitable outdoors	No
Degree of protection	IP30
Electrical data	230/400V, 16 A

Floor
outlet
boxes

UFB-700, UFB 900

Presentation



Floor outlet boxes UFB-700 & -900

Description

UFB-700 and UFB-900 are floor outlet boxes for dry premises with an in-cavity floor or a raised access floor. For casting in concrete, the floor outlet boxes should be used in conjunction with screeded floor box UFB-IG or former UFB-RF.

The rectangular UFB-700 is 220x310 mm and the square UFB-900 is 310x310 mm. The dimension of the hole in the floor is 201x292 ±1 mm for UFB-700 and 292x292 ±1 mm for UFB-900.

The required smallest installation depth for the floor outlet boxes is 110 mm and the greatest internal depth 54 mm.

The boxes are based on a grid for the outlets and connections, completed by a trim frame with a lid.

Grid

The grid has three F80® openings for CYB outlets for power, telecom and data.

Trim frame and lid

The lid that can be trimmed with any material of up to 8 mm thickness. Note, however, that hard, brittle materials like stone should be avoided, since there is a risk that they might crack.

The trim frame is provided with a flange that bears upon the flooring to conceal the edge of the hole and to outbalance the loads exerted on the box.

In the 80° opening position the lid is self-closing. When required, the lid can be kept open or completely removed by pressing down the red buttons at the hinges.





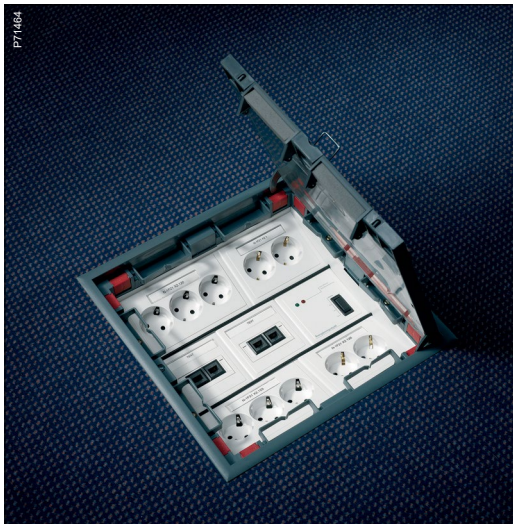

The lid is reinforced by of 4 mm thick sheet steel inlay. The strength has been tested according to DIN VDE 0634 Part 1 and it fulfils requirements according to PSA Specification MOB PF2 Jan. 1992.

Description of the strength tests and test results are available on request.



UFB-700, UFB 900 Range

UFB-700 & -900

Type	Colour	Dimensions A/B/C (mm)		Qty per package	EAN code	Ref. No.
Floor outlet box						
Complete floor outlet box including grid, trim frame and lid, with the grid mounted onto the trim frame. Suitable for raised access floors, in-cavity floors and screeded floors with a minimum height of 110 mm; in the latter case in combination with screeded floor box UFB-IG or former UFB-RF. Grid infills UFB-L165 or UFB-L252 to be used to fill empty openings in the grid. Material: PA6, sheet steel, extruded aluminium.						
 P106171	UFB-700	Grey RAL 7011	73/220/310	1	7332418020336	5197005
 P106170	UFB-900	Grey RAL 7011	73/310/310	1	7332418020343	5197055
Locking kit						
Locking kit for the lid, to be used as an extra protection against unauthorized access; opened by means of a screw-driver. Material: PA6.6 with 30% glass-fibre..						
 P67885	UFB-LL	Grey	27/36/35	1	7315885197251	5197250
Cable outlet						
Cable outlet kit, to be used if a cable outlet of UFB-700 or -900 has to be exchanged. Material: PA6.						
 P111055	UFB-CO	Grey RAL 7011	32/78/35	1	7315885150775	5150770
Former						
Former to be used when making cavities in in-cavity floors, or as an alternative to a screeded floor box in screeded floors. To be placed on the floor slab before the concrete is poured. As soon as the concrete has hardened, the former can be removed. Material: EPS (foamed).						
 P67886	UFB-RF For UFB-700	White	115/250/340	5	7315885197916	5197910
	UFB-RF For UFB-900	White	115/340/340	5	7315885197923	5197920

UFB-700, UFB 900

Description

Exploded view UFB-700 & -900

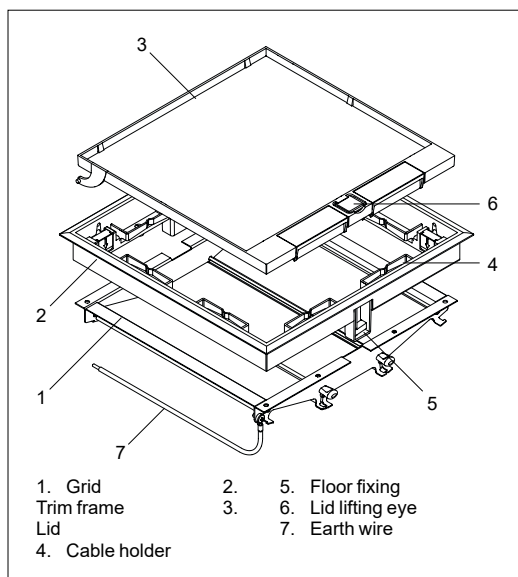

Degree of protection

Complies with IP20 in accordance with IEC 529.

Cable capacity

2x600 mm² max. cable Ø 14 mm.

Standards

- DIN VDE 0634 Teil 1
- PSA Specification MOB PF2 PS, Jan 1990

Approvals

VDE.

Material data

Extruded aluminium	Specification:	AlMg 0.5 Si (AA 6063)
Sheet steel	Specification:	S 235 JR
	Surface treatment:	Galvanized Z275
Steel (lid plate)	Specification:	S 350 GD
	Material thickness:	4 mm
	Surface treatment:	Galvanized Z 275
Spring steel (lid lifting handle)	Specification:	DIN 17223
	Surface treatment:	Electroplated Fe/Zn 5 c1
PC/ABS	Fire rating	UL 94 HB (halogen-free)
	Colour	White RAL 9016
PA6	Fire rating:	UL 94 V-2 (halogen-free)
	Colours:	•Grey RAL 7011 (≠NCS 6905-B05G) •Red
PA6.6 with 30% glass-fibre	Fire rating:	UL 94 HB (0.79 mm halogen-free)
	Colour:	Grey RAL 7011 (≠NCS 6905-B05G)
Fireflex (foam cushion)	Specification:	S305+4610 B1
	Colour:	Grey
EPS S15 (foamed polystyrene)	Colour:	White

Design and dimensions

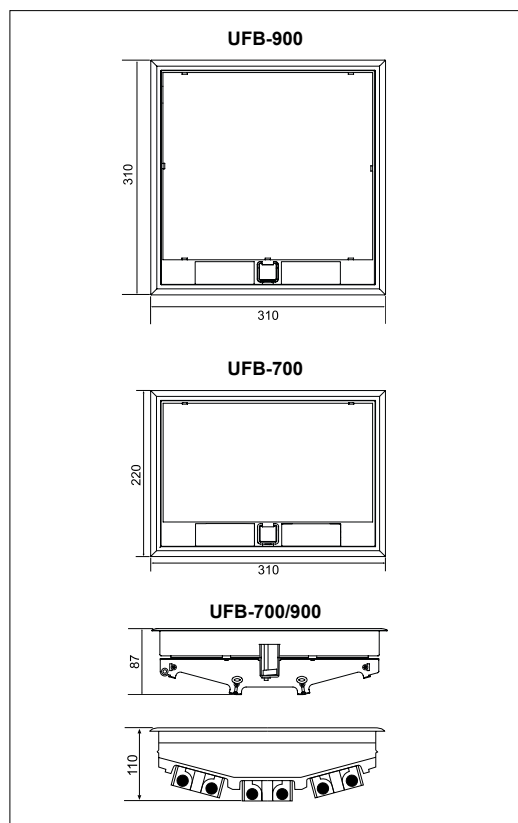

Operative data

Compatible with	<ul style="list-style-type: none"> • Floors approved for dry premises. • Raised access floors (RAF), in-cavity floors, screeded floors in conjunction with UFB-IG or UFB-RF. • Boxes CYB and MIB. • Outlet system CYB and standard outlets.
Not compatible with	<ul style="list-style-type: none"> • Floors approved to withstand water. • Floors with a smaller construction height than 110 mm. • Standard outlets with larger covering plates than 84 mm.



Floor outlet boxes UFB-700M, & -900M

Description

UFB-700M and 900M are floor outlet boxes made of stainless steel, intended for in-cavity floors or raised access floors. The boxes are mainly intended for dry premises, but if provided with a centre-positioned cable exit and completed by a special sealing, they can also be used in wet-cleaned applications. For casting in concrete, the boxes should be used in conjunction with screeded floor box UFB-IG.

Trim frame and lid







The trim frame is provided with a flange that bears upon the flooring to conceal the edge of the hole and to outbalance the loads exerted on the box.





The lid is available in two thicknesses, 15 mm and 25 mm, and with a cable exit position either in the centre or on the side. The centre cable exit can be completed by a cable exit unit with or without spacer tube.

Grid

The grid has three F80® openings for CYB outlets for power, telecom and data.

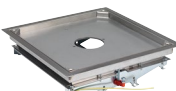
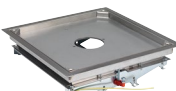
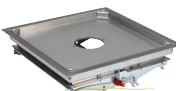

UFB-700M						
Type	Colour	Dimensions A/B/C (mm)		Qty per package	EAN code	Ref. No.
Floor outlet box for dry applications						
Complete floor outlet box including grid, trim frame and lid, supplied with earth cable, floor fixings and fixing screws. The lid is provided with a cable exit in side position and can be trimmed with optional floor material up to 15 or 25 mm thickness respectively. Suitable for dry applications in raised access floors, in-cavity floors and screeded floors with a minimum height of 115 or 125 mm respectively; in screeded floors in combination with screeded floor box UFB-IG and installation cover UFB-MP for UFB-700. Material: Stainless steel X5 CrNi 18-10.						
	UFB-700M	—	89/231/322	1	7332418020206	5198715
	15 mm lid with side exit					
	UFB-700M	—	99/231/322	1	7332418020220	5198725
	25 mm lid with side exit					
Floor outlet box for wet-cleaned floors						
Complete floor outlet box including grid, trim frame and lid, supplied with earth cable, floor fixings and fixing screws. The lid is provided with a cable exit in centre position, suitable for cable exit unit with or without spacer tube, and can be trimmed with optional floor material up to 15 or 25 mm thickness respectively. Suitable for wet-cleaned raised access floors, in-cavity floors and screeded floors with a minimum height of 115 or 125 mm respectively; in screeded floors in combination with screeded floor box UFB-IG and and installation cover UFB-MP for UFB-700. Material: Stainless steel X5 CrNi 18-10.						
	UFB-700M	—	89/231/322	1	7332418020282	5198716
	15 mm lid with centre exit					
	UFB-700M	—	89/231/322	1	7332418020213	5198717
	15 mm screw-fixed lid with centre exit					
Cable exit unit without spacer tube						
Cable exit unit without spacer tube, for UFB-700M and 900M with a centre-positioned cable exit. The cover of the unit is provided with two cavities, suitable for a special opening tool. The tool is supplied with the product. Material: Aluminium AlMg 0.5 Si (AA 6063).						
	UFB-CE	Anodized	15/Ø96	1	7315885198104	5198100
	For 15 mm lid					
Former						
Former to be used when making cavities in in-cavity floors, or as an alternative to a screeded floor box in screeded floors. To be placed on the floor slab before the concrete is poured. As soon as the concrete has hardened, the former can be removed. Material: EPS (foamed).						
	UFB-RF	White	115/250/340	5	7315885197916	5197910
	For UFB-700					

UFB-900M							
Type	Colour	Dimensions A/B/C (mm)		Qty per package	EAN code	Ref. No.	
Floor outlet box for dry applications							
Floor outlet box including grid, trim frame and lid, supplied with earth cable, floor fixings and fixing screws. The lid is provided with a cable exit in side position and can be trimmed with optional floor material up to 15 or 25 mm thickness respectively. Suitable for dry applications in raised access floors, in-cavity floors and screeded floors with a minimum height of 115 or 125 mm respectively; in screeded floors in combination with screeded floor box UFB-IG and and installation cover UFB-MP for UFB-900. Material: Stainless steel X5 CrNi 18-10.							
	UFB-900M	—	89/322/322	1	7332418020244	5198915	
	15 mm lid with side exit						
	UFB-900M	—	99/322/322	1	7332418020268	5198925	
	25 mm lid with side exit						
Floor outlet box for wet-cleaned floors							
Floor outlet box including grid, trim frame and lid, supplied with earth cable, floor fixings and fixing screws. The lid is provided with a cable exit in centre position, suitable for cable exit unit with or without spacer tube, and can be trimmed with optional floor material up to 15 or 25 mm thickness respectively. Suitable for wet-cleaned raised access floors, in-cavity floors and screeded floors with a minimum height of 115 or 125 mm respectively; in screeded floors in combination with screeded floor box UFB-IG and installation cover UFB-MP for UFB-900. Material: Stainless steel X5 CrNi 18-10.							
	UFB-900M	—	89/322/322	1	7332418020305	5198916	
	15 mm lid with centre exit						
	UFB-900M	—	89/322/322	1	7332418020251	5198917	
	15 mm screw-fixed lid with centre exit						
	UFB-900M	—	99/322/322	1	7332418020312	5198926	
	25 mm lid with centre exit						
Cable exit unit without spacer tube							
Cable exit unit without spacer tube, for UFB-700M and 900M with a centre-positioned cable exit. The cover of the unit is provided with two cavities, suitable for a special opening tool. The tool is supplied with the product. Material: Aluminium AlMg 0.5 Si (AA 6063).							
	UFB-CE	Anodized	15/Ø96	1	7315885198104	5198100	
	For 15 mm lid						
Former							
Former to be used when making cavities in in-cavity floors, or as an alternative to a screeded floor box in screeded floors. To be placed on the floor slab before the concrete is poured. As soon as the concrete has hardened, the former can be removed. Material: EPS (foamed).							
	UFB-RF	White	115/340/340	5	7315885197923	5197920	
	For UFB-900						

UFB-700M, UFB900M

Technical description

Design and dimensions

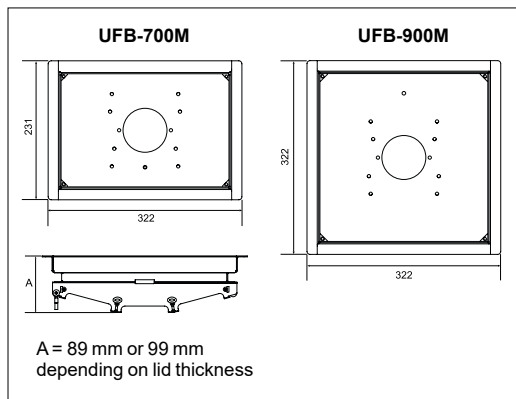

Exploded view

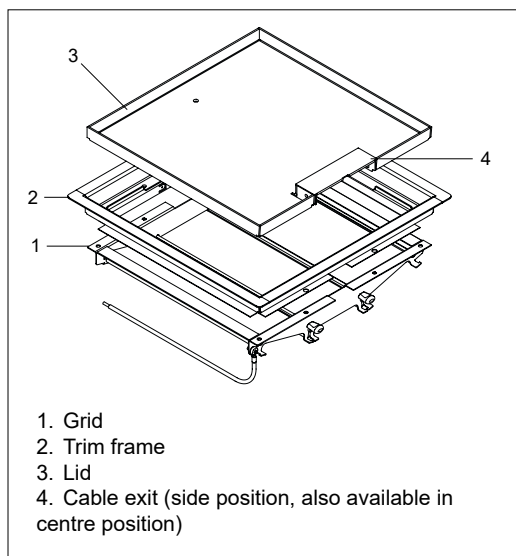

Dimensions

	External dim., mm	Dim. of hole in floor, mm	Smallest inst. depth, mm
UFB-700M, lid 15	231x322	201x292 ±1	115
UFB-700M, lid 25	231x322	201x292 ±1	125
UFB-900M, lid 15	322x322	292x292 ±1	115
UFB-900M, lid 25	322x322	292x292 ±1	125

The greatest internal depth is 52 mm.

Degree of protection

Complies with IP20 in accordance with IEC 529.

Cable capacity

UFB-700M/900M	Cable exit in side position: one 14x97 mm (1358 mm ²)
	Cable exit in centre position
	– with spacer tube: two 12x40 mm (2x480 mm ²)
	– without spacer tube: one Ø67 mm

Standards

- DIN VDE 0634 Teil 1
- PSA Specification MOB PF2 PS, Jan 1990

Material data

Extruded aluminium	Specification:	AlMg 0.5 Si (AA 6063)
Aluminium	Specification:	AlMg 0.5 Si (AA 6063)
	Surface treatment:	Anodizing
Sheet steel	Specification:	S 235 JR
	Surface treatment:	Galvanized Z275
Stainless steel	Specification:	X5CrNi 18-10
PC/ABS	Fire rating:	UL 94 HB (halogen-free)
	Colour:	White RAL 9016
Foam rubber	Colour:	Black

Operative data

- Compatible with
- Raised access floors (RAF) and in-cavity floors
 - Screeded floors in conjunction with UFB-IG
 - Floors approved for dry premises (NOTE! Boxes provided with a sealing and with cable exit in centre position can be used in floors approved for wet cleaning)
 - Boxes CYB and MIB.
 - Outlet system CYB and standard outlets.
- Not compatible with
- Floors with a smaller construction height than
 - 115 mm for UFB-700M/900M with 15 mm lid
 - 125 mm for UFB-700M/900M with 25 mm lid
 - Standard outlets with larger covering plates than 84 mm.

UFB-800

Presentation

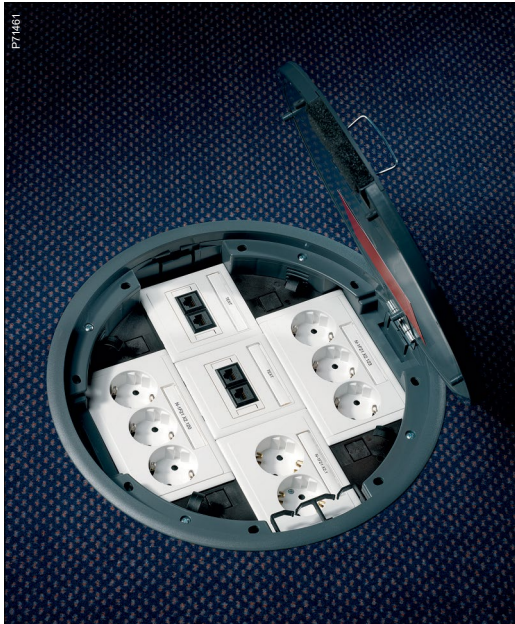

Floor outlet box UFB-800

Description

UFB-800 is a round floor outlet box for dry premises. For casting in concrete, UFB-800 should be used with screeded floor box UFB-IG or former UFB-RF.

UFB-800 requires a minimum depth of 70 mm in a finished floor and a hole with a diameter of 305 ± 1 mm.

Grid

The grid holds up to twelve outlets for 230 V (CYB-PS triple Schuko). In the three F80® openings in the grid, five standard outlets $\square 84$ mm, can be installed. The grid also has four 17.5x18.2 mm knockouts for Actassi modular outlets.

The grid is attached to matrix positions in the trim frame with four combined lifting handles/fasteners. The matrices have a pitch of 5 mm and require a floor depth from 70 to 100 mm. The internal unobstructed depth of the floor outlet box is then 15 to 45 mm. A minimum floor depth of 75 mm is required for an angled standard plug in a schuko outlet, and a floor depth of at least 85 mm is required for an angled data cover (CYB-BK1).

The grid can be detached from the trim frame and lid, which means that it can be supplied separately and installed in conjunction with other installation work.

Trim frame and lid

The trim frame is available in two different colours, with a lid that can be trimmed with any material of up to 5 mm thickness. The patented floor fixing devices function irrespective of the depth of the floor or the type of wall in the hole. The floor fixing expands as the screw is inserted, giving a large contact surface and permitting attachment in both hard and porous floor materials.

The trim frame is provided with a flange that bears upon the flooring to conceal the edge of the hole and to outbalance the loads exerted on the box.

The lid can be opened in two positions; either through 80°, in which case it is self-closing, or through 180° during service. The lid can be installed facing in four directions (at 90° intervals) without having to rotate the installation.

The lid is reinforced with a 4 mm sheet steel plate. The strength has been tested according to DIN VDE 0634 Part 1 and it fulfils requirements according to PSA Specification MOB PF2 Jan. 1992.

Description of the strength tests and test results are available on request.

UFB-800 with accessories

Type	Colour	Dimensions A/B/C (mm)		Qty per package	EAN code	Ref. No.
Floor outlet box, complete						
Complete floor outlet box including grid, trim frame and lid. The lid can be installed in four positions. The grid has three F80® openings (1x284 and 2x142) for installation of power, telecommunications and data outlets, and four 17.5x18.2 mm knockouts for Actassi modular outlet. The knockouts can also be used for conduits when an uninterrupted cable is to pass through the box. The grid is snapped into the trim frame and is adjustable in seven steps from 70 mm to 100 mm. Grid infill UFB-L142 to be used to fill empty openings in the grid. Suitable for raised access floors, in-cavity floors and screeded floors with a minimum height of 70 mm; in the latter case in combination with screeded floor box UFB-IG. Material: PA/ABS, PA6.6 with 35% glass-fibre, sheet steel S 350 GD.						
UFB-800	Grey Anthracite	64/Ø329		1	7315885197107 7315880044512	5197100 5197104
Former						
Former to be used instead of core-drilling in in-cavity floors, or as an alternative to a screeded floor box in screeded floors. Material: EPS (foamed).						
UFB-RF	White	120/Ø305		5	7315880053309	5197915

P8768B



P8789A



UFB -800

Technical description

Exploded view UFB-800

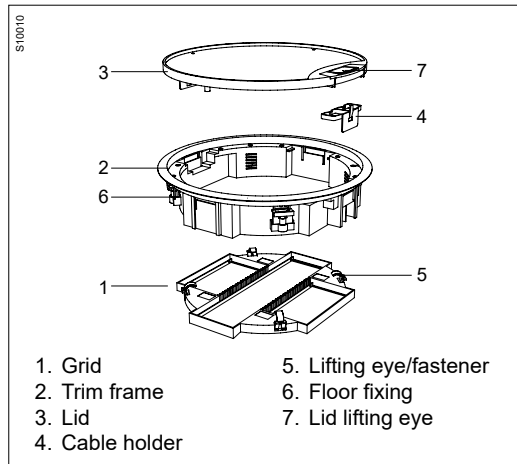

Design and dimensions

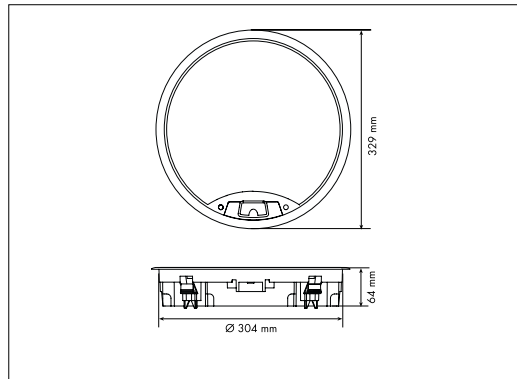

Degree of protection

Complies with IP20 in accordance with IEC 529.

Cable capacity

1200 mm² max. Ø 13 mm in the cable exit.

Standards

- DIN VDE 0634 Teil 1
- PSA Specification MOB PF2 PS, Jan 1990

Material data

PA6.6 with 35% glass-fibre	Fire rating:	UL 94 V-0 (halogen-free)
	Colour:	Black
PA6.6 with 30% glass-fibre	Fire rating:	UL 94 HB (0.79 mm halogen-free)
	Colour:	Black
PA6 med 15% glass-fibre (insulation)	Fire rating:	UL 94 HB
	Colour:	Black
PA6 (cable holder)	Fire rating:	UL 94 V-2 (halogen-free)
	Colour:	Black
PA/ABS	Fire rating:	UL 94 HB (halogen-free)
	Colours:	Grey RAL 7011 (≈NCS 6905-B05G) Anthracite RAL 7016 (≈NCS 7905-B02G)
PC/ABS	Fire rating:	UL 94 V-0 (1.6 mm halogen-free)
	Colours:	White RAL 9016
Steel (lid plate)	Specification:	S 350 GD
	Material thickness:	4 mm
	Surface treatment:	Galvanized Z 275
Steel (hinge)	Specification:	S 235 JR
	Surface treatment:	Galvanized
Spring steel (lid lifting handle)	Specification:	DIN 17223
	Surface treatment:	Fe/Zn 5 c1
Aluminium (cutting template)	Specification:	AlSi 1.5 Mn
	Colour:	Natural
Fireflex (foam cushion)	Specification:	S305+4610 B1
	Colour:	Grey
EPS S15 (polystyrene)	Colour:	White

Operative data

Compatible with	<ul style="list-style-type: none"> • Floors approved for dry cleaning. • Raised access floors (RAF), in-cavity floors, screeded floors in conjunction with UFB-IG or former UFB-RF. • Boxes CYB and MIB. • Outlet system CYB and standard outlets.
Not compatible with	<ul style="list-style-type: none"> • Floors approved to withstand water. • Floors with a smaller construction height than 70 mm. • Standard outlets with larger covering plates than 84 mm.

UFB-IG with accessories

Type	Colour	Dimensions A/B/C (mm)	Qty per package	EAN code	Ref. No.
Screeded floor box for floors 70–110 mm					
<p>Screeded floor box for floor embedment in screeded floors from 70 to 110 mm thickness. For floors thicker than 110 mm, add spacer frame UFB-MG as an enhancement. The box height is adjustable, the adjustment being made in all four corners to make it possible to always level the box to the finished floor. The box is supplied including spacer frame and three blank plates UFB-AP. Suitable for floor outlet boxes type UFB and service posts type POS mounted in mounting plate UFB-MP. Material: Sheet steel S 235 JR, aluminium AC - AISi 9 Cu 3 (Fe).</p>					
UFB-IG	Galvanized	110/455/455	1	7315885197565	5197560
Screeded floor box for floors 110–150 mm					
<p>Screeded floor box for floor embedment in screeded floors from 110 to 150 mm thickness. For floors thicker than 150 mm, add spacer frame UFB-MG as an enhancement. The box height is adjustable, the adjustment being made in all four corners to make it possible to always level the box to the finished floor. The box is supplied including spacer frame and three blank plates UFB-AP. Suitable for floor outlet boxes type UFB and service posts type POS mounted in mounting plate UFB-MP. Material: Sheet steel S 235 JR, aluminium AC - AISi 9 Cu 3 (Fe).</p>					
UFB-IG	Galvanized	140/455/455	1	7315880047681	5197565
Spacer frame					
<p>Spacer frame to be screw-fastened to screeded floor box UFB-IG, increasing the height by 40 mm. Several spacer frames can be mounted on top of one another to further increase the height. Material: Aluminium AC - AISi 9 Cu 3 (Fe).</p>					
UFB-MG	—	47/370/370	1	7315885197558	5197550
Blank plate					
<p>Blank plate to be fitted to the side entrance of screeded floor box UFB-IG. Material: Sheet steel S 235 JR.</p>					
UFB-AP	—	1.5/55/257	10	7315880046813	5197750
Conduit adaptor					
<p>Adaptor for the connection of 1–4 conduits Ø 50 mm (dimensions acc. to EN 60423) to screeded floor box UFB-IG. When required, the conduit dimension can be reduced by reduction sleeve UFB-RM. All conduit entrances are provided with knock-out opening. Material: PP.</p>					
UFB-AP	Yellow	55/40/257	10	7315885197756	5197755
Reduction sleeve					
<p>Reduction sleeve for the connection of conduits in adaptor UFB-AP. The reduction sleeve is available for four different conduit dimensions: Ø 16, Ø 20, Ø 32 and Ø 40 mm (dimensions acc. to EN 60423). The hole for the conduit connection is positioned at the bottom edge of the reduction sleeve, for a steady position of the conduit. Material: PP.</p>					
UFB-RM	Yellow	Ø50/39	10	7315885197824	5197820
For conduits Ø 16 mm					
UFB-RM	Yellow	Ø50/39	10	7315880046820	5197825
For conduits Ø 20 mm					
UFB-RM	Yellow	Ø50/39	10	7315885197831	5197830
For conduits Ø 32 mm					
UFB-RM	Yellow	Ø50/39	10	7315880046837	5197835
For conduits Ø 40 mm					

UFB-IG with accessories

Type	Colour	Dimensions A/B/C (mm)		Qty per package	EAN code	Ref. No.
Installation cover						
Installation cover for UFB floor boxes and service post POS-200, to be mounted in screeded floor box UFB-IG. Material: Sheet steel S 235 JR, zinc coated.						
UFB-MP For UFB-700	Galvanized	3/361/361		1	7315885197787	5197785
UFB-MP For UFB-800	Galvanized	3/361/361		1	7315880046844	5197790
UFB-MP For UFB-900	Galvanized	3/361/361		1	7315885197794	5197795



PE7902

UFB-IG

Technical description

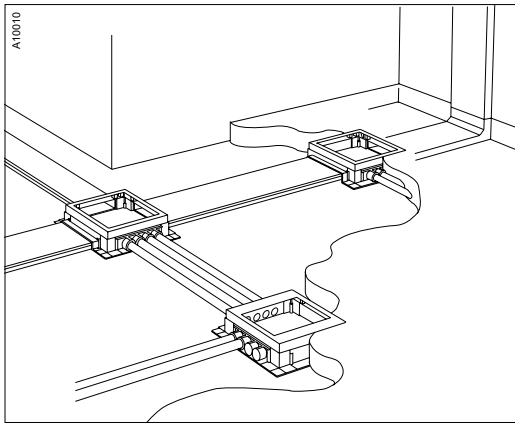
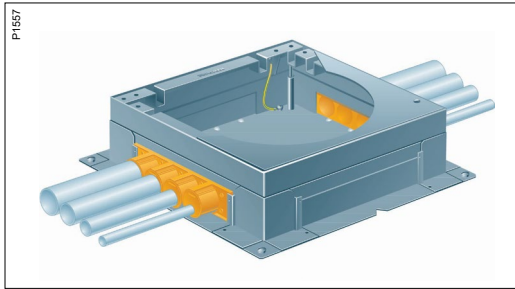

Screeded floor boxes UFB-IG

Description

Screeded floor boxes UFB-IG are to be placed on the floor slab, which is then covered by concrete screed (Fig. 1). If the shuttering formwork is to be removed after the casting, the box must be placed with a concrete layer under the box.

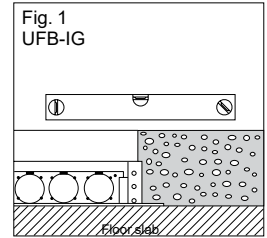

UFB-IG

For UFB-IG the minimum depth of the concrete layer should be 70 mm and 110 mm respectively.

UFB-IG can be continuously adjusted to a height of 70–110 mm and 110–150 mm respectively. By using one or several spacer frames UFB-MG, the depth can be increased in steps of 40 mm per frame.

All four sides of UFB-IG can be opened for connections by using adaptors UFB-AP for various applications. UFB-AP adaptors are available in three different designs for the connection of conduits or trunkings. The conduit adaptor can be adjusted to four different conduit dimensions by using reduction sleeves.

The box is supplied with one side open and the other three sides covered by blank plates, and is provided with a top plate intended to prevent concrete from leaking into the box. After the casting the top plate is to be replaced by installation cover UFB-MP.

Exploded view

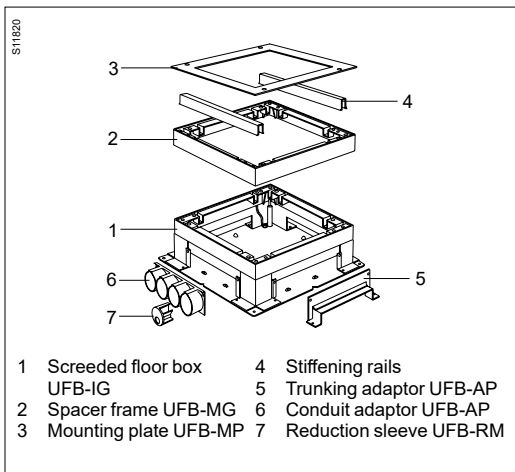

Standards

Tested to DIN VDE 0634 Teil 1 and PSA.MOB PF2 PS, Jan 1990.

Adaptor UFB-AP and reduction sleeve UFB-RM for conduits with dimensions acc. to EN 60423.

Material data

Steel	Specification:	S 235 JR
	Surface treatment:	Galvanized
Sheet steel	Specification:	S 235 JR
	Surface treatment:	Zinc (Z275)
Aluminum	Specification:	AC - AISi 9 Cu 3 (Fe)
PP (polypropylene)	Fire rating:	UL 94 HB halogen-free
	Colours:	Yellow NCS 0080-Y20R Blue Grey Natural PP colour

Cable capacity

	Cable dia. Max Ø	Cross section area, mm ²	Cable capacity, mm ²		
			40%	50%	60%
Conduit adaptor UFB-AP	37	1040	416	520	624
Conduit adaptor UFB-AP + UFB-RM 40	35	984	394	492	590
Conduit adaptor UFB-AP + UFB-RM 32	27	606	242	303	364
Conduit adaptor UFB-AP + UFB-RM 20	16	224	90	112	134
Conduit adaptor UFB-AP + UFB-RM 16	13	132	53	66	79

Design and dimensions

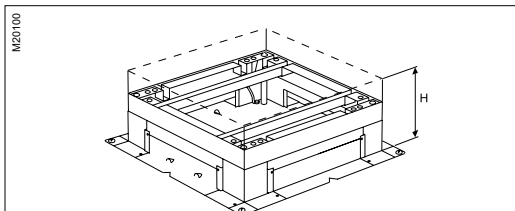

The measure H must not be smaller than the stated minimum screed depth for floor outlet boxes.

Type	H, mm	Remarks
UFB-800	75/85	75 mm for 250 V, 85 mm for angled CYB data
UFB-700/900	110	CYB
UFB-700/900	115	MIB-A1, -A2

Operative data

Temperature range	From -20 to +60°C
Suitable outdoors	Not suitable
Degree of protection	IP 20
Estimated min. length of service	More than 15 years
Restrictions	Only for the mounting of floor boxes UFB and post POS-200

Furniture units



Description

The customized Thorsman SBO boxes are made up by a base profile of aluminium, provided with stop ends and including service content, F80® front covers, connections, terminations, cable glands and mounting accessories according to customer specification.

The customer has a design option from the Thorsman SBO menu, which contains:

- Two different profile types.
- Different types of stop end, some of which may also be used to mount the box.
- Different colours (use the Ref.No. and add the desired NCS or RAL colour and gloss).
- Optional length of up to 5 m.
- Mounting of the box
 - on the wall
 - suspended under a shelf, standing on a desk or suspended on brackets under an installation trunking
- The major part of our menu for service content, including power outlets, switches, time control units, telephone/low current outlets, data outlets, circuit breakers, earth leakage breakers, surge protectors, signal lamps, blank covers and connection terminals.
- Connection of chosen units to one another, to connection terminal or to external cable stand of optional length.

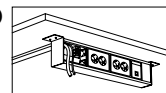

Each box is supplied including wiring diagram, test report, guarantee certificate and mounting instruction.

Software

The boxes are specified by means of the computerized planning and specifying tool Combinum. This will enable a customer specific choice of model, size, colour, mounting accessories/options, service content, connections and cable entrance to the box.

Design and dimensions

Total length of box*)

	With flat stop ends	With angled stop ends
SBO-A123	A+B+113 mm	A+B+190 mm
SBO-A123-4	—	A+B+190 mm

*) The total length of the box is specified by the customer. It is determined by the following parameters:

- The service content specified by the customer (A).
- The fixed measure of the front cover pieces (B).
- The specified stop ends.

NOTE! If cable glands have been chosen for the stop ends this will also influence the actual length of the box.

Front covers, left and right

A = Place for service content
 B = Fixed measure of front cover between stop end and service content:

INKA profiles: 55 mm

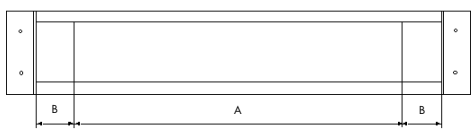

Exploded view

General layout

Parts always included in any customized offer:

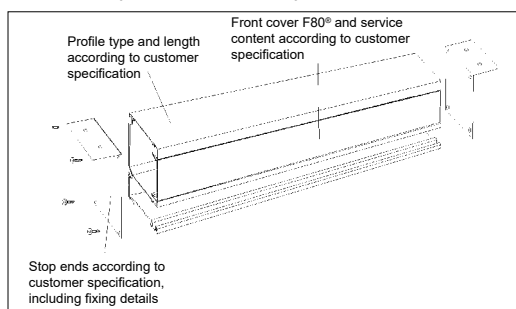

Material and Operative data

INKA profile, front covers and stop ends	Material	Aluminium
	Surface treatment	Natural anodized or powder coated
	Colour	Acc. to customer spec.
Suitable outdoors	Not suitable	
Degree of protection	IP30	
Electrical data	230/400V, 16A	

Range

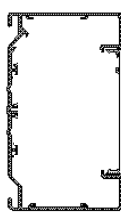
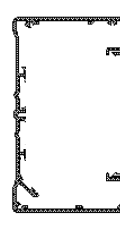
	Customized offer	
	SBO-A123	SBO-A123-4
Based on profile	INKA-123	INKA-123-4
		
T-No. base	GCR_CMS9383	GCR_CMS9384
Internal Id-No.	20034905	20034906
Height x depth, mm	Aluminium 121x72	Aluminium 145x72
length, mm	5000	5000

Dedicated
wiring
devices



Description

Service content type CYB is a system intended for front F80 mounting in service carriers such as perimeter trunking, service poles and posts, service boxes and floor outlet boxes. A choice of products is also available for mounting on recessed c/c 60 mm boxes.

This product document includes socket outlets and switches, as well as accessories like indicating lamps, junction boxes, terminal blocks.

F80 mounting without box

The master and slave socket outlets are mounted without box. This system consists of a triple master outlet, which can be extended with any number of double slave outlets. The combination is ended by an end piece, which is easily pushed in between the side of the outlet and the front cover.

Marking, termination and strain relief are done on the master socket outlet.



Exploded views

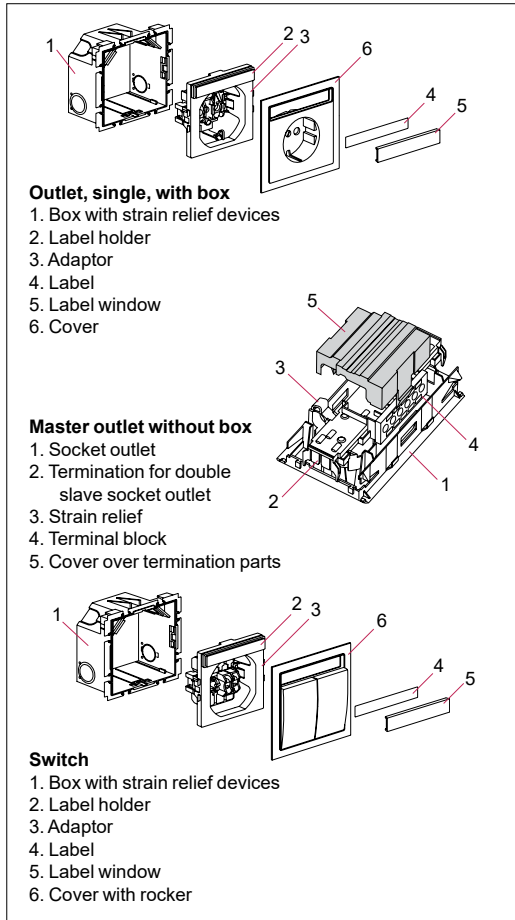

Technical data

Electrical data	16 A / 250 V.
Standards	
Connection kit, switch	SS-EN 60669-1
Connection kit, outlet, with overvoltage protector	DIN VDE 0675 Part 6 Class C
Connection kit, outlet	IEC 884-1, DIN 0606
Approvals	
Connection kit, outlet	SEMKO, NEMKO, FIMKO, VDE and KEMA
Connection kit, outlet without child protection	SEMKO, KEMA, VDE
Connection kit, outlet, with overvoltage protector	SEMKO, VDE

Material data

Material PC/ABS	Density	1.14 g/cm ³
	Fire rating	UL 94 HB (halogen-free)
Material PA6/ABS	Fire rating	UL 94 HB (halogen-free)
Material PA	Fire rating	UL 94 HB (halogen-free)
Material PA6, 30% glass-fibre	Fire rating	UL 94 HB (halogen-free)
Material PA6, 15% glass-fibre	Fire rating	UL 94 HB
Material ASA	Fire rating	UL 94 HB (halogen-free)
Material ABS DH / AS	Fire rating	UL 94 HB (1.7 mm)
Material PMMA N8	Fire rating	UL 94 HB

Colour spec.

White RAL 9016	
White RAL 9010	
White RAL 1013	
Light grey	= NCS 1902-Y24R
Greyish-black	= NCS 7603-R74B
Black	= RAL 9005
Red	= NCS 3754-Y97R ≈ RAL 3003
Orange	≈ RAL 2003
Green	≈ RAL 6029
Aluminium metallic	

Operative data

Temperature range	From -20°C to +40°C
Suitable outdoors	No
Degree of protection	IP20

Mounting instructions

Mounting instructions are enclosed with the product.	
Connection kit, single	20002500
CYB-AD1	MI 2257
CYB-PB on TED	20017802
CYB-PF	20002995
CYB-PS single on TED	20017191
CYB-PS master/slave	20045620
- overv. prot. TN, term.guide	20046238
- overv. prot. IT, term.guide	20046239





CYB connection kits, master outlet

P4881



P4881



Type	Colour	Dimensions A/B/C (mm)		Qty per package	EAN code	Ref. No.
Triple master socket outlet, push-in						
Triple connection kit including socket/cover plate (in one piece) with earthing system, two strain relief devices, push-in terminal block and label window with label. Also including cover to be fitted over the termination, and end piece that snap-fits on either side of the outlet. Shuttered. Hole pattern 37°. Green, orange and red for priority power supply. To be combined with double slave socket outlets. Material: PC/ABS.						37° 
CYB-PS	White RAL 9016	84/50/142		1	7315885940116	5940110
	White RAL 9010				7315880103288	5940111
	White RAL 1013				7315880103295	5940112
	Alu metallic				7315880107279	5940113
	Green				7332418021326	5951677
	Red				7332418021340	5951679
	Black				3606481069306	INS60701
CYB-PS	White RAL 9016	84/50/142		1	7315885940154	5940150
Marked DATA	Alu metallic				7315880107316	5940153
CYB-PS	White RAL 9016	84/50/142		1	7315885940253	5940250
With green LED indication	Alu metallic				7315880108665	5940253
Triple master socket outlet, screw						
Triple connection kit including socket/cover plate (in one piece) with earthing system, two strain relief devices, screw terminal block and label window with label. Also including cover to be fitted over the termination, and end piece that snap-fits on either side of the outlet. Shuttered. Hole pattern 37°. To be combined with double slave socket outlets. Material: PC/ABS.						37° 
CYB-PS	White RAL 9016	84/50/142		1	7332418017299	5941500
	Alu metallic				7332418017305	5941505
	Black				3606481069313	INS60702
CYB-PS	White RAL 9016	84/50/142		1	7332418017329	5941515
Marked DATA	Alu metallic				7332418017336	5941520
Triple master socket outlet, push-in, without label window						
Triple connection kit including socket/cover plate (in one piece) with earthing system, two strain relief devices and push-in terminal block. Also including cover to be fitted over the termination, and end piece that snap-fits on either side of the outlet. Shuttered. Hole pattern 37°. To be combined with double slave socket outlets. Material: PC/ABS.						37° 
CYB-PS	White RAL 9010	84/50/142		1	7332418016902	5940310
	White RAL 1013				7332418016919	5940311
	Alu metallic				7332418016926	5940312

CYB connection kits, master outlet

Type	Colour	Dimensions A/B/C (mm)		Qty per package	EAN code	Ref. No.
------	--------	--------------------------	---	--------------------	----------	----------

Triple master socket outlet, push-in, with installation couplers

Triple connection kit including socket/cover plate (in one piece) with earthing system, two strain relief devices, push-in terminal block and label window with label. Also including cover to be fitted over the termination, and end piece that snap-fits on either side of the outlet. With two halogen-free cables (30 cm free length), and 3x2.5 mm² wire and male and female installation couplers. Child protection. Hole pattern 37°.

To be combined with double slave socket outlets.

Material: PC/ABS.

37°



CYB-PS	White RAL 9016	84/50/142		1	7315885940208	5940200
With Wieland cables	White RAL 9010				7315880107323	5940201
	White RAL 1013				7315880114048	5940202

P61976



Triple master socket outlet, push-in, with installation couplers

Triple connection kit including socket/cover plate (in one piece) with earthing system, two strain relief devices and push-in terminal block (without label window). Also including cover to be fitted over the termination, and end piece that snap-fits on either side of the outlet. With two halogen-free Wieland cables (110 cm free length) with 3x2.5 mm² wire and male and female installation couplers. Child protection. Hole pattern 37°. To be combined with double slave socket outlets.

Material: PC/ABS.

37°















CYB-PS	White RAL 9010	84/50/142		1	3606480523540	INS69000
---------------	----------------	-----------	--	---	---------------	-----------------

P140233



CYB connection kits, slave outlet

Type	Colour	Dimensions A/B/C (mm)		Qty per package	EAN code	Ref. No.
Double slave socket outlet						
Double slave socket outlet to be plugged into the master or another slave socket outlet. Including end piece that snap-fits on either side of the outlet. Shuttered. Hole pattern 37°. Material: PC/ABS.						37° 
	CYB-PS	White RAL 9016	84/39/94	1	7315885940017	5940010
		White RAL 9010			7315880103264	5940011
		White RAL 1013			7315880103271	5940012
		Alu metallic			7315880107286	5940013
		Black			3606481069290	INS60700
CYB-PS	White RAL 9016	84/39/94		1	7315885940079	5940075
Big-pack (packed in a set including 45 pcs)						
CYB-PS	White RAL 9016	84/39/94		1	7332418015257	5940015
Marked DATA	Alu metallic				7332418015288	5940018
Double slave socket outlet, kitwith push-in adaptor						
Double slave socket outlet including an end piece with label window that snap-fits on one side of the outlet and a CYB-AC adaptor with push-in termination on the other side. The adaptor includes a protective cover that is fitted under the front cover of trunking, poles, etc., and two snap-in function strain relief devices. Allows one incoming and one outgoing cable, max 3x2.5 mm ² . To be plugged into another slave socket outlet. Shuttered. Hole pattern 37°. Material: PC/ABS.						37° 
	CYB-PS	White RAL 9016	84/39/160	1	7332418019897	5940044
		White RAL 9010			7332418015479	5940021
		Alu metallic			7332418015486	5940023
Double slave socket outlet, kitwith screw adaptor						
Double slave socket outlet including an end piece with label window that snap-fits on one side of the outlet and a CYB-AC adaptor with screw termination on the other side. The adaptor includes a protective cover that is fitted under the front cover of trunking, poles, etc., and two snap-in function strain relief devices. Allows one incoming and one outgoing cable, max 3x2.5 mm ² . To be plugged into another slave socket outlet. Shuttered. Hole pattern 37°. Material: PC/ABS.						37° 
	CYB-PS	White RAL 9016	84/39/160	1	7332418019903	5941216
		Alu metallic			7332418017404	5941205
Double slave socket outlet including an end piece that snap-fits on one side of the outlet, and a CYB-AD adaptor on the other side. The adaptor includes screw terminal block, protective cover with label window, and two snap-in function strain relief devices. Allows one incoming and one outgoing cable, max 3x2.5 mm². To be plugged into another slave socket outlet. Shuttered. Hole pattern 37°. Material: PC/ABS.						
	CYB-PS	White RAL 9016	84/39/125	1	7332418017398	5941200
Double slave socket outlet, kitwith push-in adaptor						
Double slave socket outlet including two end pieces that snap-fit on either side of the outlet and a CYB-AC adaptor with push-in termination on one side. The adaptor includes a protective cover that is fitted under the front cover of trunking, poles, etc., and two snap-in function strain relief devices. Allows one incoming and one outgoing cable, max 3x2.5 mm ² . To be plugged into another slave socket outlet. Shuttered. Hole pattern 37°. Material: PC/ABS.						37° 
	CYB-PS	White RAL 1013	84/39/145	1	7332418021265	5951511
		White RAL 9010			7332418021272	5951512
Double slave socket outlet, kit with Wieland adaptor						
Double slave socket outlet including an end piece that snap-fits on one side of the outlet, and CYB-AD adaptor for Wieland 3-pole male interface GST-18 on the other side. The adaptor includes protective cover with label window. To be plugged into another slave socket outlet. Shuttered. Hole pattern 37°. Material: PC/ABS, PA6.						37° 
	CYB-PS	White RAL 9016	84/39/140	1	7332418015295	5940025

CYB connection kits, slave outlet

P89550



Type	Colour	Dimensions A/B/C (mm)		Qty per package	EAN code	Ref. No.
Double slave socket outlet, pre-wired kit with Wieland installation couplers						
Double slave socket outlet including CYB-ET earth terminal, CYB-AD adaptor with push-in terminal block and protective cover with label window, and end piece that snap-fits on one side of the outlet. Pre-wired with connection cable type H05VV-F3G including male and female Wieland installation couplers. Cable length 2x1.4 m. To be plugged into another slave socket outlet. Shuttered. Hole pattern 37°. Material: PC/ABS.						37°
CYB-PS 1.5 mm ² cable	White RAL 9016 White RAL 9010	84/39/125		1	7332418015332 7332418015349	5940030 5940031
CYB-PS 2.5 mm ² cable	White RAL 9016 White RAL 9010 White RAL 1013	84/39/125		1	7332418015370 7332418015387 7332418015394	5940035 5940036 5940037

P89549



2 x double slave socket outlet, kit with push-in adaptor						
A combination of two double slave socket outlets with an end piece with label window that snap-fits on one side of the combination and a CYB-AC adaptor with push-in termination on the other side. The adaptor includes a protective cover that is fitted under the front cover of trunking, poles, etc., and two snap-in function strain relief devices. Allows one incoming and one outgoing cable, max. 3x2.5 mm ² . To be plugged into another slave socket outlet. Shuttered. Hole pattern 37°. Material: PC/ABS.						37°
CYB-PS	White RAL 9016 Alu metallic	84/39/250		1	7332418015417 7332418015448	5940040 5940043

CYB accessories, master & slave outlet

P85701



Adaptors						
Adaptor including terminal block and protective cover with label window. With two snap-in function strain relief devices. Allows one incoming and one outgoing cable, max. 3x2.5 mm ² . To be used in combination with CYB-PS double slave socket outlet. Material: PC/ABS.						
CYB-AD Push-in terminal block	White RAL 9016 White RAL 9010 Alu metallic	84/41/37		1	7315885940055 7315880113478 7315880113492	5940050 5940051 5940053
CYB-AD Screw type terminal block	White RAL 9016 White RAL 9010 Alu metallic	84/41/37		1	7315880114857 7315880114864 7315880114888	5940055 5940056 5940058

CYB accessories, master & slave outlet



Label holder						
Label holder including label and window. Material: PC/ABS.						
CYB-AD Label holder	White RAL 9016 Alu metallic Black	84/20/23		1	3606486524718 3606486524725 3606486524732	5940070 5940071 5940072



CYB accessories, master & slave outlet

Type	Colour	Dimensions A/B/C (mm)		Qty per package	EAN code	Ref. No.
Adaptors						
Adaptor for Wieland 3-pole male interface GST-18 without cover. To be used in combination with CYB-PS double slave socket outlet. Material: PA6.						
CYB-AD	—	55/59/34		1	7315880114895	5940065
Adaptor for Wago Winsta 3-pole male interface without cover. To be used in combination with CYB-PS double slave socket outlet. Material: PA6.						
CYB-AD	—	55/59/34		1	3606481006585	5940067
Earth terminal						
Earth terminal including a 25 cm cable with flat pin connector for earth connection of trunking base or cover. Suitable for triple master and double slave outlet CYB-PS. Material: PA6.						
CYB-ET	—	41/23		10	7315880113539	5961502
Blank cover						
Blank cover to be used in combination with master socket outlet CYB-PS. To be exchanged for double slave socket outlet when required. Material: PC/ABS.						
CYB-PL	White RAL 9016 White RAL 1013	84/28/87		1	7315880112617 7315880112624	5961559 5961561
End piece						
End piece intended for CYB-PS master and slave socket outlets. Snap-fits on either side of the outlet and locks the outlet in the trunking. Material: PC/ABS.						
CYB-ES	White RAL 9016 Alu metallic	84/20.1/7		10	7315885940406 7315880114024	5940400 5940403

CYB USB Chargers

Type	Colour	Dimensions A/B/C (mm)		Qty per package	EAN code	Ref. No.
CYB USB Type A+C						
USB charger connection kit includes box, USB insert, adaptor, two strain relief devices, cover, and label with label window. The USB-A provides a maximum of 18 W power and supports fast charging. The USB-C provides a maximum of 21 W power and supports PD fast charge. Together, USB-A and USB-C ports provide a maximum of 17 W of power and a maximum of 2.4 A for each port. Nominal input voltage: 220-240 V AC. USB output voltage: 5-12 V DC Material: PC/ABS.						
CYB USB Type A+C	White Alu	84/84/84		1	3606487391067 3606487391074	INS60528 INS60529
CYB USB Type C						
USB charger connection kit including box, USB insert, adaptor, two strain relief devices, cover and label with label window. Maximum currents is 3.25 A. Nominal input voltage: 100-240 V AC. USB output voltage: 5-20 V DC (only for charger PD/QC) Material: PC/ABS.						
CYB USB Type C	White Alu	84/84/84		1	3606482043831 3606482043848	INS60526 INS60527

CYB connection kits, outlet

Type	Colour	Dimensions A/B/C (mm)		Qty per package	EAN code	Ref. No.
Single connection kit, outlet						
Single connection kit including socket with earthing system, box, adaptor, two strain relief devices, cover and label with label window. Shuttered, push-in termination. Hole pattern 90°. Material: PC/ABS, PA.						90° 
CYB-PS	White RAL 9016	84/52/84		1	7315885975002	5975000
	White RAL 9010				7315880072805	5975001
	Alu metallic				7315880079088	5975002
Triple connection kit, outlet, European standard						
Triple connection kit acc. to European standard, Class II, including socket, box, adaptor, two strain relief devices, cover and label with label window. Shuttered, with screw termination. Material: PC/ABS.						
CYB-PE	White RAL 9016	84/46/84		1	7315885975507	5975500
Connection kit, CEE outlet						
Connection kit including single phase CEE outlet (Bals), installation box with strain relief devices, frame with label window and four screws. Material: PC.						
CYB-PC	White/red	82/110/82		1	7315880060543	5960105

CYB device kits, outlet/switch

Device kit, CEE outlet						
Device kit including single phase CEE outlet (Bals) and frame with label window. To be screw-fastened on box MIB-A1 by four included screws. To be combined with front cover kit. Material: PC.						
CYB-C220	Grey/blue	82/70/82		1	7315885960114	5960110
	CEE-216-6 250V/16A					
CYB-C380	Grey/red	82/70/82		1	7315885960107	5960100
	CEE-416-6 440V/16A					
Device kit, switch						
Switch device kit including box, switch insert, adaptor and two strain relief devices. Switch-on position upwards. 250V 16A. To be combined with front cover kit. Material: PC/ABS, PA.						
CYB-PB	White	80/50/84		1	7315880074472	5980206
1-pole spring-return						
CYB-PB	White	80/50/84		1	7315880074557	5980286
Venetian blind						

CYB connection kits, switch

P2183



P139322



P139323



Type	Colour	Dimensions A/B/C (mm)	Qty per package	EAN code	Ref. No.
Connection kit, switch, one rocker					
CYB-PB 1-pole 2-way	up White RAL 9016 Alu metallic	84/52/84	1	7315880074243 7315880079064	5980052 5980054
Connection kit, switch, two rockers					
Switch connection kit including box, switch insert, adaptor, two strain relief devices, cover with two rockers and label with label window. Switch-on position downwards or upwards. 250V 10A. Material: PC/ABS.					
CYB-PB 2-gang	up White RAL 9016	84/52/84	1	7315880074281	5980072
CYB-PB Venetian blind/1-pole switch	up White RAL 9016	84/52/84	1	7315880074304	5980082
CYB-PB Venetian blind	up White RAL 9016	84/52/84	1	7315880074342	5980087
CYB-PB 2-gang, spring-return	up White RAL 9016	84/52/84	1	3606481958563	5980077

Wiring diagrams of switches

<p>D13930</p> <p>1-pole</p>	<p>D13920</p> <p>Spring-return</p>	<p>D13900</p> <p>1-pole with indication</p>	<p>D13950</p> <p>2-pole</p>	<p>D13910</p> <p>2-way</p>
<p>D13970</p> <p>Intermediate</p>	<p>D13940</p> <p>Double</p>	<p>D13980</p> <p>Venetian blind/1-pole switch</p>	<p>D13960</p> <p>2-pole 2-way</p>	<p>D13990</p> <p>Venetian blind</p>

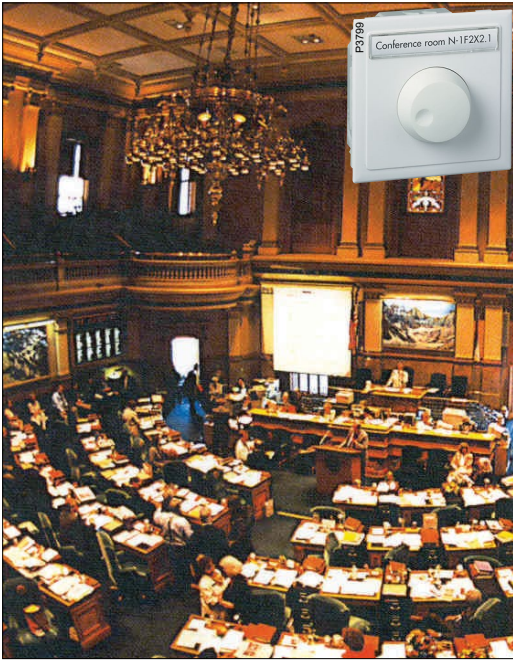

Operative data

Temperature range	+5°C +35°C
Suitable outdoors	No
Degree of protection	IP20

Material data

Box, Cover, Adaptor,	Material	PC/ABS
Mounting frame, Mounting plates	Fire rating	UL 94 HB (halogen-free)
	Colour spec.	• White • Aluminium metallic
Device unit	Material	PA6
	Colour spec.	White
Window holder	Material	PC/ABS
Label window	Material	PMMA
	Fire rating	UL 94 HB

Exploded views

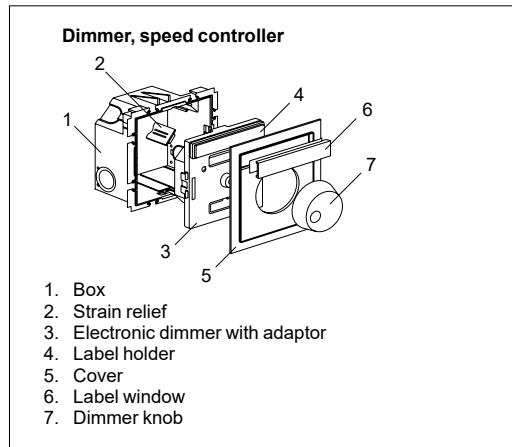

CYB-PR Power supply kit

P72822

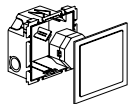

Type	Colour	Dimensions A/B/C (mm)	Qty per package	EAN code	Ref. No.
Power supply kit					
Power supply kit for 4xLexCom home switch. Input 230 VAC and output 12 V DC, 0.5 A. Including box with strain relief, terminal block, power supply device and cover. Material: PC/ABS.					
CYB-PR	White	84/41.2/84	1	7315885972704	5972700

CYB-PR Dimmer

P3799



Type	Colour	Dimensions A/B/C (mm)	Qty per package	EAN code	Ref. No.
CYB-PR Uni LED Dimmer					
Uni LED rotary dimmer 400W kit including box, adaptor, dimmer insert, two strain relief devices, knob, cover and label with label window. Nominal voltage: AC 230 V, 50/60 Hz					
Switching capacity:					
LED lamps (RC mode): 4-200 VA					
LED lamps (RL LED mode): 4-40 VA					
Incandescent lamps: 4-400 W					
230 V halogen lamps: 4-400 W					
LV halogen lamps with dimmable wound transformer: 4-400 VA					
LV halogen lamps with electronic transformer: 4-400 VA					
Neutral conductor: Not required					
Connecting terminals: Screw terminals for max. 2.5 mm ²					
Protection: 16 A circuit breaker					
Properties:					
• Short-circuit-proof					
• Overload-proof					
• Soft start					
• Resistant to overheating					
• Automatic load detection					
Material: PC/ABS.					
CYB-PR Uni LED	White	84/54/84	1	3606481333674	INS60530
400 W/VA	Alu		1	3606481333681	INS60531

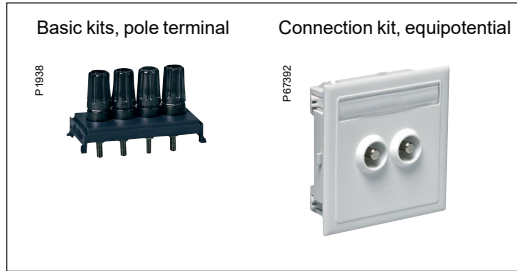

Description

Basic kit, pole terminal

The product consists of a mounting plate to be mounted in CYB-BK flat or angled cover. The mounting plate includes four pole terminals which are connected to one another by an earth rail.

Connection to the pole terminals can be made according to the following:

- 1 Pole terminal with 4 mm terminal tags.
- 2 Cable clip with a minimum opening of 5 mm.
- 3 Connection cable with a maximum core diameter of 2 mm.

Connection kit, equipotential

The product consists of cover, mounting frame and a steel insert including two pole terminals.

Connection to the pole terminals can be made with the Thorsman plug CTA-PO. Maximum earth cable size 4x16 mm².

Exploded views

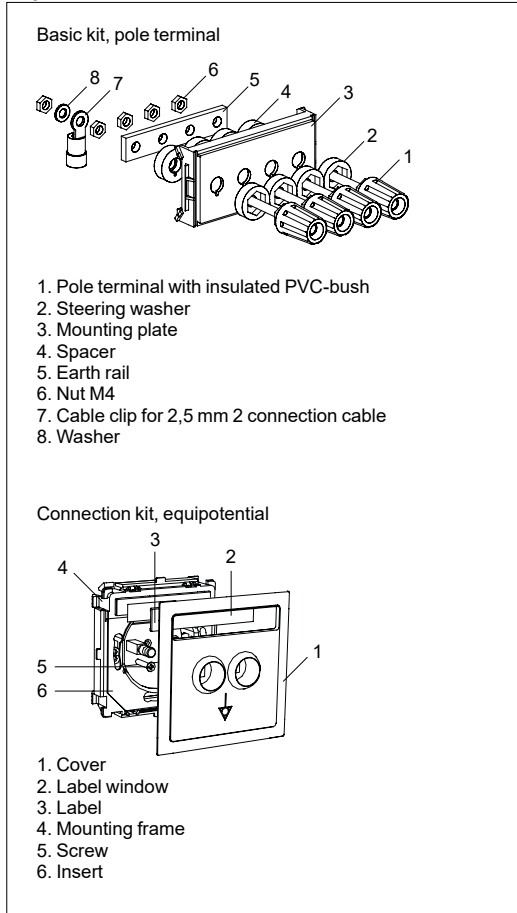

Material data

Basic kits

Mounting plate	Material	PC/ABS
	Fire rating	UL 94 HB halogen-free
	Colour spec.	Greyish-black NCS 7603-R74B
Earth rail DIN	Material	Copper ISO Cu-OF, SS 5011-04, OF-Cu, BS C103

Connection kit, equipotential

Cover, mounting frame	Material	PC/ABS
	Fire rating	UL 94 HB halogen-free
	Colour spec. cover	<ul style="list-style-type: none"> • White RAL 9016 • White RAL 9010 • White RAL 1013 • Grey NCS S 5502-B
Insert	Material	Steel

Operative data

Temperature range	From -40°C to +70°C
Suitable outdoors	No

CYB-PO Basic and connection kits

Type	Colour	Dimensions A/B/C (mm)	Qty per package	EAN code	Ref. No.
Basic kit, pole terminal					
Basic kit including mounting plate with pole terminals, for equipotential function. Intended for flat or angled covers CYB-BK. Material: PC/ABS, copper.					
CYB-PO	Greyish-black	44/32/67	1	7315880060611	5971831

CYB-PN

Presentation



Description

CYB-PN product range includes a 4-module enclosure for mounting in service carriers with front F80®.

4-module enclosure with hinged lid

4-module enclosure that can handle between one and four DIN modules, provided with a hinged lid for protection of the DIN devices and available with or without locking function of the lid. For both horizontal and vertical mounting.

Standards

DIN VDE.

Approvals

Approved by VDE and SEMKO.

Material data

CYB-PN	Material	PC/ABS
	Colour spec.	<ul style="list-style-type: none"> • White RAL 9016 • White RAL 9010 • White RAL 1013 • Grey NCS S 5502-B

Electrical data

CYB-PN	16 A, 400 V
	Maximum cable size = 5x2.5 mm ²

Operative data

Temperature range:	From -25° to +40°C
Suitable outdoors:	No
Degree of protection:	IP20

Exploded view

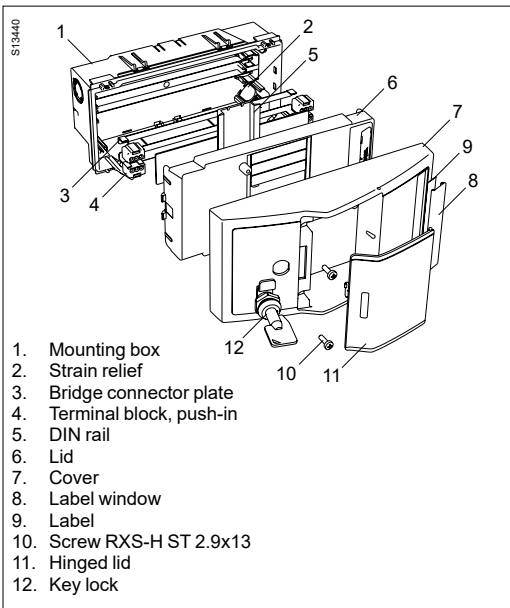

1. Mounting box
2. Strain relief
3. Bridge connector plate
4. Terminal block, push-in
5. DIN rail
6. Lid
7. Cover
8. Label window
9. Label
10. Screw RXS-H ST 2.9x13
11. Hinged lid
12. Key lock

DIN enclosures

Type	Colour	Dimensions A/B/C (mm)	Qty per package	EAN code	Ref. No.
4-module DIN enclosure with hinged lid					
4-module DIN enclosure intended for snap-in mounting in service carriers with front F80®. The enclosure is suitable for 1–4 DIN modules and has a hinged lid to protect the devices. Material: PC/ABS.					
CYB-PN	White RAL 9010	84/86/168	1	7315885960251	5960250
	White RAL 9016			7315880083986	5960251



Description









Mounting boxes CYB-S30 and D30 are provided with screw pillars M3.5 and meet British standard for the mounting of screw-fastened standard outlets. They are available in two sizes, single box S30 and double box D30, with a box depth of 30 mm.

Mounting boxes CYB-S40 and D40 have no screw pillars for standard devices. However, in combination with screw pillar CYB-P40, available as an accessory, the boxes will fulfil British standard.

Thorsman frameless CYB outlets for the UK market, as well as standard outlets can be installed in the boxes.

In the single box outlets can be mounted either vertically or horizontally.

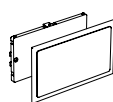
Mounting boxes with accessories, blank cover

Type	Colour	Dimensions A/B/C (mm)		Qty per package	EAN code	Ref. No.	
Mounting box, double							
Front-mounted and snap-fastened mounting box with 14 entries Ø 16 mm, adapted to snap-fastened strain relief devices and conduit bush. The entries are two on each short side, four on each long side and two at the bottom. Ten of the entries can be increased to Ø 19,5 mm for pipe connection. At the bottom of the box there is room for earth terminal CYB-ET. To be used in conjunction with CYB-PU and CYB-PL. Material: PC.							
P139325		CYB-D40	White RAL 9016	79/44/142	10	7315880043867	5961035
Mounting box, single							
Front-mounted and snap-fastened mounting box with ten entries Ø 16 mm, adapted to snap-fastened strain relief devices and conduit bush. The entries are two per short side, two per long side and two at the bottom. They can be increased to Ø 19,5 mm for pipe connection. At the bottom of the box there is room for earth terminal CYB-ET. To be used in conjunction with CYB-PU, CYB-PL and CYB-DP. Material: PC.							
P139326		CYB-S40	White RAL 9016	79/44/84	10	7315885961036	5961030
Mounting box with screw pillars, double							
Front-mounted and snap-fastened mounting box with ten entries Ø 16 mm, adapted to snap-fastened strain relief devices and conduit bush. The entries are two on each short side, two on each long side and two at the bottom. Two screw pillars M 3.5 for screw-fastened standard devices with a centre distance of 120.6 mm. At the bottom of the box there is room for earth terminal CYB-ET. To be used in conjunction with CYB-PU, CYB-PL and outlets according to British Standard. Material: PC.							
P139327		CYB-D30	White RAL 9016	79/32/142	10	7315880046943	5961005
Mounting box with screw pillars, single							
Front-mounted and snap-fastened mounting box with six entries Ø 16 mm, adapted to snap-fastened strain relief devices and conduit bush. The entries are two on each short side and two at the bottom. Four screw pillars M 3.5 for screwfastened standard devices with a centre distance of 60,3 mm. At the bottom of the box there is room for earth terminal CYB-ET. To be used in conjunction with CYB-PU, CYB-PL, CYB-DP and outlets according to British Standard. Material: PC.							
P64410		CYB-S30	White RAL 9016	79/32/84	10	7315885961005	5961000
Screw pillar for mounting box							
Screw pillar with thread bush M 3.5, to be snap-fastened in mounting box CYB-S40 and CYB-D40. For the mounting of screw-fastened standard outlets. Material: PA6, 15% glass-fibre.							
L44390		CYB-P40	White	14/12/37	20	7315880044352	5961505
Blank cover							
Snap-fastened blank cover, including adaptor and front plate. To be used as a blank cover for future expansion or own hole-making. To be mounted in double box CYB-D40/CYB-D30 or single box CYB-S40/CYB-S30. Material: PA, ASA.							
L44370		CYB-PL For double box CYB-D40/D30	White RAL 9016	84/12/142	1	7315880043874	5961555
P64417		CYB-PL For single box CYB-S40/S30	White RAL 9016	84/12/84	1	7315885961555	5961550
Twin outlet kit, standard, 13 A							
Twin basic outlet kit standard 13 A without switch, including adaptor with outlet and front plate. To be mounted in double box CYB-D40 or CYB-D30. Material: PA, ASA.							
P139331		CYB-PU	White RAL 9016	84/25/142	1	7315880043928	5961235

Outline

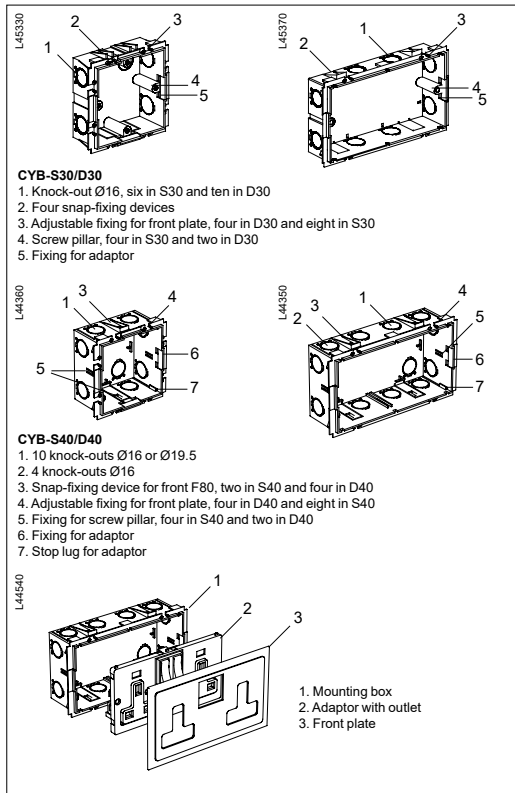

Standards

Mounting boxes: BS 4662:1970
 Standard power outlets: BS 1363:1984

Approvals

Dual master telephone outlet has been approved by British Telecom.

Material data

Mounting box	Material	PC (polycarbonate)
	Fire rating	UL 94 V-0 (1,6 mm halogen-free)
	Colour spec.	White RAL 9016
Screw pillar	Material	PA.6 (polyamide), 15% glass-fibre
	Fire rating	UL 94 HB
	Colour	White
Adaptor	Material	PA (polyamide)
	Fire rating	UL 94 HB (halogen-free)
	Colour spec.	Black NCS 9500
Front plate	Material	ASA
	Fire rating	UL 94 HB (halogen-free)
	Colour spec.	• White RAL 9016 • Grey NCS S 5502-B

Operative data

Temperature range	From +80°C to -40°C
Suitable outdoors	No
Degree of protection	IP20
Restrictions	Only for use in products with front F80
Environmental sensitivity	Direct contact with solvents

Compatibility

Not suitable for Products with other front opening than F80 or with a depth below 52 mm (S40/D40) and 42 mm (S30/ D30).

Design and dimensions

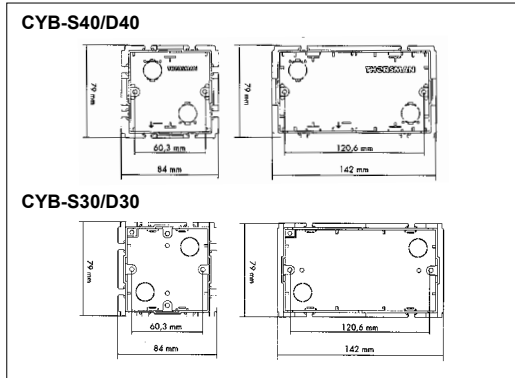

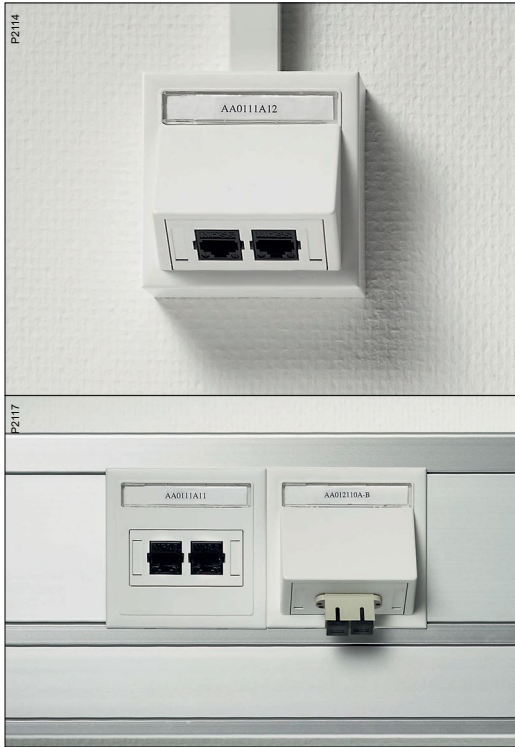

Description

CYB low voltage service content system is designed to fit service carriers with F80® front opening. In addition, it can be mounted on the wall or installed in an apparatus box.

The system is frameless and boxless and is made up by snap-fitted covers with mounting plates and connectors. The covers are available in angled or flat design.

The mounting kits CYB-BK include mounting frame, cover, label and label window.

Put together with various mounting plates and connectors the mounting kits make complete connection kits.







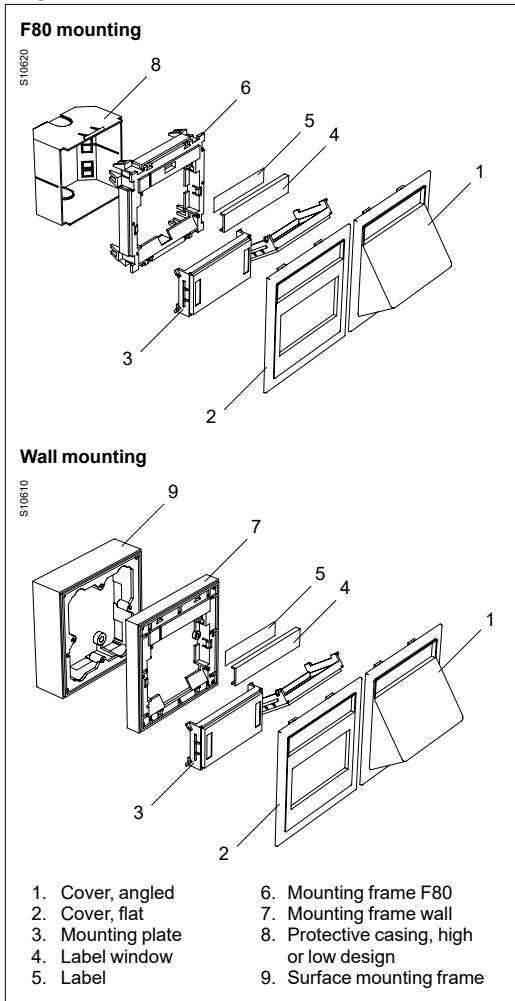





Material data











Cover in RAL-specified colour	Material	PC/ABS
	Fire rating	UL 94 HB (halogen-free)
	Colour	<ul style="list-style-type: none"> • White RAL 9010 • White RAL 1013
Other covers, wall mounting frame	Material	ASA
	Fire rating	UL 94 HB (halogen-free)
	Colour	<ul style="list-style-type: none"> • White = RAL 9016 • Light grey = NCS 1902-Y24R • Greyish-black = NCS 7603-R74B • Aluminium metallic
Box CYB-S40	Material	PC (polycarbonate)
	Fire rating	UL 94 V-0 (1.6 mm halogen-free)
	Colour	White RAL 9016
Mounting frame for F80 products, mounting frame for installation boxes	Material	PC/ABS
	Fire rating	UL 94 HB (halogen-free)
	Colour	<ul style="list-style-type: none"> • White RAL 9016 • White RAL 9010 (only frame for installation boxes)
Mounting plates, front plates	Material	PC/ABS
	Fire rating	UL 94 HB (halogen-free)
	Colour mounting plates	<ul style="list-style-type: none"> • White = RAL 9016 • White RAL 9010 • White RAL 1013 • Greyish-black = NCS 7603-R74B
	Colour front plates	<ul style="list-style-type: none"> • White = RAL 9016 • White RAL 9010
Adaptor for overvoltage protector (CYB-DS)	Material	PA (polyamide)
	Fire rating	UL 94 HB (halogen-free)
Surface mounting frame	Material	ASA
	Fire rating	UL 94 HB (halogen-free)
	Colour	<ul style="list-style-type: none"> • White = RAL 9016 • Light grey = NCS 1902-Y24R • Greyish-black = NCS 7603-R74B
Label window	Material	PMMA N8
	Fire rating	UL 94 HB
	Colour	Clear
Fibre spool	Material	PE-HD
	Colour	Natural
Protective casings CYB-RK, CYB-DF	Material	PP (polypropylene)
	Fire rating	UL 94 HB (halogen-free), withstands glow-wire test 750°
	Colour	<ul style="list-style-type: none"> • Red = NCS 2080-Y80R • White = RAL 9016 (fibre)

Exploded views



Mounting kits

Type	Colour	Dimensions A/B/C (mm)		Qty per package	EAN code	Ref. No.
For F80® mounting						
Mounting kit including F80 mounting frame, snap-fitted cover in angled or flat design, label window and label. For mounting in service carriers with 80 mm front. Material: See Material data on previous pages.						
 P3712	CYB-BK1	White RAL 9016	84/50/84	1	7315885970007	5970000
		White RAL 9010			7315880042655	5970003
		Alu metallic			7315880079125	5970004
		White RAL 1013			7315880083863	5970005
		Black			3606481069320	INS60703
 P3713	CYB-BK2	White RAL 9016	84/25/84	1	7315885970021	5970020
		White RAL 9010			7315880042679	5970023
		Alu metallic			7315880079118	5970024
		White RAL 1013			7315880083870	5970025
 P1930	CYB-BK6	White RAL 9016	84/25/84	1	7315885970090	5970090
		White RAL 9010			7315880067856	5970093
 P4640	CYB-BK7	White RAL 9016	84/30/84	1	7315885970106	5970100
		With mounting frame adapted to c/c 60 mm devices and SE national telephone socket with screw terminals				
 P6419	CYB-BK8	White RAL 9016	84/25/84	1	7315880084426	5970105
		White RAL 9010			7315880084433	5970106
		Alu metallic			7315880104322	5970107
 P66835	CYB-BK9	White RAL 9016	84/25/84	1	7315885970113	5970110
		With mounting frame adapted to c/c 60 mm devices and cover with hole pattern suitable for aerial socket outlets type R+TV				
 P6416	CYB-BK10	White RAL 9016	84/25/84	1	7315880084457	5970115
		With mounting frame adapted to c/c 60 mm devices and cover with square hole pattern acc. to DIN 49075. Without label window.				
 P6415	CYB-BK11	White RAL 9016	84/25/84	1	7315885970120	5970120
		With mounting frame adapted to c/c 60 mm devices and cover with hole pattern for low voltage outlet of Mosaic type				
 P6409	CYB-BK12	White RAL 9016	84/22/84	1	7315885970137	5970130
		Alu metallic			7315880108252	5970133
 P6409	CYB-BK12	White RAL 9016	84/22/84	1	7315885970137	5970130
		Alu metallic			7315880108252	5970133
 P6409	CYB-BK12	White RAL 9016	84/22/84	1	7315885970137	5970130
		Alu metallic			7315880108252	5970133
 P6409	CYB-BK12	White RAL 9016	84/22/84	1	7315885970137	5970130
		Alu metallic			7315880108252	5970133

Mounting kits							
Type	Colour	Dimensions A/B/C (mm)		Qty per package	EAN code	Ref. No.	
For F80® mounting							
Mounting kit including holder, snap-fitted flat cover, two label windows and two labels. Intended for LexCom Home switch 4+1 port, 10/100 Mbps. Requires 12V DC external power supply. For snap-fitting in service carriers with 80 mm front opening. NOTE! Not compatible with TAS+. Material: Holder = Steel, Cover = PC/ABS.							
P64400		CYB-BK13	White RAL 9016	84/35/84	1	7315885970144	5970140
For wall mounting							
Mounting kit including wall mounting frame, snap-fitted cover in angled or flat design, label window and label. For mounting directly on the wall or by means of a surface mounting frame, or on a recessed box (c/c 60 mm). Material: See Material data on previous pages.							
P3714		CYB-BK3	White RAL 9016	84/40/84	1	7315885970045	5970040
P3715		CYB-BK4	White RAL 9016	84/13.5/84	1	7315885970069	5970060
Cables for multimedia cables							
Multimedia cables intended to be used together with mounting plate CYB-DP Keystone and mounting kits CYB-BK in angled or flat version. Keystone connector interface in one end and female connector in the other end. Material: HF plastic							
P150284		HDMI cable, Keystone/Female	-	5/10/200	1	3606485435329	INS64220
P150273		Audio jack 3.5 mm cable, Keystone/Female	-	5/10/200	1	3606485435251	INS64221
P150272		USB 3.0 cable, Keystone/Female	-	5/10/200	1	3606485435374	INS64222
Mounting plate for multimedia cables							
Mounting plate for multimedia cables, intended for use with mounting kits CYB-BK1, 2, 3 and 4. With label holder, can be mounted angled or flat, and they can all be fitted without tools. Material: PC/ABS.							
P60140		CYB-DP AMP Keystone with label holder	White RAL 9016	12/32/66	10	7315880052883	5971714
Multimedia kits							
Multimedia kits include F80 mounting frame, label window with label, angled cover, mounting plate and one HDMI/USB/3.5 mm Phono connectors respectively.							
P150284 P15928		CYB kit angled HDMI	White RAL 9016	84/50/84	1	3606481298348	INS60510
P150272 P15928		CYB kit angled USB	White RAL 9016	84/50/84	1	3606481298355	INS60511
P150273 P15928		CYB kit angled Phono	White RAL 9016	84/50/84	1	3606481298362	INS60512

Mounting plates

	Type	Colour	Dimensions A/B/C (mm)	Qty per package	EAN code	Ref. No.
	Mounting plates with various hole patterns, intended for use with mounting kits CYB-BK and with OptiLine 50 angled basic kit for CYB plates. The plates are available in three versions; with label holder, without label holder and with built-in shutter. Plates with shutter only fit CYB-BK6. All plates except those with built-in shutter for CYB-BK6 can be mounted angled or flat, and they can all be fitted without tools. Material: PC/ABS.					
	Without label holder With label holder With dust shutter					
	Blank plates					
P2018	CYB-MP1 Blank plate without label holder, for future expansion or for hole cutting by client	White RAL 9010 White RAL 9016	12/32/66	10	7315885971851 7315885971707	5971850 5971700
P60150	CYB-MP2 Blank plate with label holder, for future expansion or for hole cutting by client	White RAL 9016	12/32/66	10	7315880052791	5971701
	BNC, TNC, EAE					
P2020	CYB-DC Keyed hole for 1 x BNC, TNC, EAE, with label holder	White	12/32/66	10	7315880052807	5971705
P60453	CYB-DC Keyed double holes for 2 x BNC, TNC or EAE-2, with label holder	White	12/32/66	10	7315880052814	5971706
	F, ST for cable TV or fibre					
P143106	CYB-DC Keyed double holes for 2 x F or ST, with label holder, for cable TV nets or fibre	White RAL 9016	12/32/66	10	7315880052838	5971708
	Thomas & Betts					
P2024	CYB-DP Thomas&Betts for 2 x 8-position modular jack STP, UTP and blind plug, with label holder	White RAL 9016	17/32/66	10	7315880052852	5971711
	Lucent					
P2025	CYB-DP Lucent for 2 x 8-position modular jack UTP and blind plug, with label holder	Greyish-black White RAL 9010 White RAL 9016	12/32/66	10	7315880040125 7315880042303 7315880052869	5971809 5971859 5971712
	AMP NetConnect					
P60140	CYB-DP AMP NetConnect for 2 x 8-position modular jack UTP Category 3 and blind plug, with label holder	White RAL 9016	12/32/66	10	7315880052876	5971713
	AMP NetConnect					
P60140	CYB-DP AMP NetConnect for 2 x 8-position modular jack STP, UTP, Krone Keystone UTP/STP and blind plug, with label holder	Greyish-black White RAL 9010 White RAL 9016 White RAL 1013	12/32/66	10	7315880040149 7315880042310 7315880052883 7315880083917	5971812 5971861 5971714 5971958
	IBM					
P2027	CYB-DP 1 x IBM cable system connector type 1, with label holder	White RAL 9016	12/32/66	10	7315880052890	5971715

Mounting plates							
	Type	Colour	Dimensions A/B/C (mm)		Qty per package	EAN code	Ref. No.
1 x D-sub							
P2030		CYB-DP	Greyish-black	12/32/66	10	7315880040156	5971813
		1 x D-sub 9 pole, with label holder	White RAL 9016				7315880052937
P60457		CYB-DP	White RAL 9016	12/32/66	10	7315885971721	5971720
		1 x D-sub 15 pole, with label holder					
P2032		CYB-DP	White RAL 9016	12/32/66	10	7315880052944	5971721
		1 x D-sub 25 pole, without label holder					
XLR, universal type							
P60458		CYB-DP	White RAL 9016	12/32/66	10	7315880052951	5971722
		1 x XLR, universal type (male and female fit in the same hole pattern), with label holder					
Modular Jack UTP & STP, Reichle & De-Massari							
P143107		CYB-DP	White RAL 9016	18/32/66	10	7315880053019	5971728
		1 x 8-position modular jack UTP & STP, Reichle & De-Massari, without label holder					
P143108		CYB-DP	White RAL 9010	18/32/66	10	7315880042426	5971873
		2 x 8-position modular jack UTP & STP, Reichle & De-Massari, without label holder.	White RAL 9016				7315880053026
1 port module, Reichle & De-Massari, FreeNet							
P2037		CYB-DP	White RAL 9010	18/32/67	10	7315880078968	5971888
		2 x 1 port module from Reichle & De-Massari, FreeNet, without label holder	White RAL 9016				7315880078944
SC Duplex from AMP, Molex, Lucent Tech (Lucent), Dätwyler, Siecor							
P2038		CYB-DF	White RAL 9016	12/32/66	10	7315885971738	5971730
		1 x SC Duplex from AMP, Molex, Lucent Tech (Lucent), Dätwyler, Siecor, with label holder					
P60460		CYB-DF	White RAL 9016	12/32/66	10	7315880053033	5971731
		2 x SC Duplex from AMP, Molex, Lucent Tech (Lucent), Dätwyler, Siecor, with label holder					
2 x 8-position modular jack, only for mounting in CYB-BK6							
P2040		CYB-DP	White RAL 9016	11/43/66	10	7315880067498	5971732
		AMP NetConnect, Krone KM8 and others, 2 x 8-position modular jack STP, UTP, with integrated shutters.	White RAL 9010				7315880067535
		CYB-DP	White RAL 9016	14/43/66	10	7315880067528	5971735
		Like the above but for Krone K8, PremisNet, Keystone 2 x 8-position modular jack STP, UTP					
Alcatel 8-pole modular jack type LAN							
L63860		CYB-DP	White RAL 9016	12/32/66	10	7315880097440	5971742
		Alcatel 8-pole modular jack type LAN mark-6, with label holder					

Mounting plates

	Type	Colour	Dimensions A/B/C (mm)		Qty per package	EAN code	Ref. No.
	Panduit MINI-COM™, Mini-Jack or Opto-Jack						
P2042	CYB-DP 2 x Panduit MINI-COM™, Mini-Jack or Opto-Jack, with label holder	White RAL 9010 White RAL 9016	21/32/66		10	7315880066729 7315880066712	5971884 5971737
	Actassi modular 125/250						
P60455	CYB-DP 2 x Actassi modular outlet 125/250 with mounting adaptors, with label holder	Greyish-black White RAL 9010 White RAL 9016 White RAL 1013	12/32/66		10	7315885971844 7315880073925 7315885971745 7315880097501	5971840 5971887 5971740 5971962
	VGA and telephone						
P143112	CYB-DP 1 x VGA and 1 x tele-phone socket Ø3.5, 3-pole, without label holder	Greyish-black White RAL 9016	12/32/66		10	7315880114185 7315880114192	5971838 5971749

Connection kits for F80® mounting, including connectors

	Type	Colour	Dimensions A/B/C (mm)		Qty per package	EAN code	Ref. No.	
L62150 L54680	Duplex SC/SC Multimode							
	CYB-DF Angled cover, Duplex SC/SC Multimode with two screws	White RAL 9016	84/50/84		1	7315885970380	5970380	
L62150 L54670	CYB-DF Angled cover, 2 x duplex SC/SC Multimode with four screws	White RAL 9016	84/50/84		1	7315880062325	5970385	
	Actassi 125 Cat 5e STP							
L62570 L58890 L57190	CYB-DP Angled cover, 1 x Actassi 125 Cat 5e STP, blind plug and black mounting adaptor	White RAL 9016	84/50/84		1	7315885970496	5970490	
	CYB-DP Angled cover, 2 x Actassi 125 Cat 5e STP, black mounting adaptors	White RAL 9016	84/50/84		1	7315880075325	5970495	
	Actassi 125 Cat 5e STP							
	CYB-DP Flat cover, 2 x Actassi 125 Cat 5e STP, black mounting adaptors	White RAL 9016	84/25/84		1	7315880075349	5970915	
L62560 L59890 L57190	Actassi 125 Cat 5e UTP							
	CYB-DP Angled cover, 1 x Actassi 125 Cat 5e UTP, blind plug and black mounting adaptor	White RAL 9016	84/50/84		1	7315885970489	5970480	
	CYB-DP Angled cover, 2 x Actassi 125 Cat 5e UTP, black mounting adaptors	White RAL 9016 Alu metallic White RAL 1013	84/50/84		1	7315880075318 7315880104049 7315880115748	5970485 5970487 5970488	
	Actassi 125 Cat 5e UTP							
	CYB-DP Flat cover, 2 x Actassi 125 Cat 5e UTP, black mounting adaptors	White RAL 9016	84/25/84		1	7315880075332	5970905	
L62570 L58890 L57190	Actassi 250 Cat 6 STP							
	CYB-DP Angled cover, 1 x Actassi 250 Cat 6 STP, blind plug and black mounting adaptor	White RAL 9016	84/50/84		1	7315885974104	5974100	
	CYB-DP Angled cover, 2 x Actassi 250 Cat 6 STP, black mounting adaptors	White RAL 9016 White RAL 9010	84/50/84		1	7315880097570 7315880104308	5974105 5974107	
	CYB-DP Flat cover, 2 x Actassi 250 Cat 6 STP, black mounting adaptors	White RAL 9016	84/34/84		1	7315880102502	5974106	

Connection kits for F80® mounting, including connectors

Type	Colour	Dimensions A/B/C (mm)		Qty per package	EAN code	Ref. No.
Connection kit including F80 mounting frame, label window with label, flat or angled cover, mounting plate and connector(s). Depending on the connector(s), the kits can be used for structured cabling networks for pair cables, general low voltage, coaxial or fibre connection. Material: PC/ABS.						
Actassi 250 Cat 6 UTP						
CYB-DP Angled cover, 1 x Actassi 250 Cat 6 UTP, blind plug and black mounting adaptor	White RAL 9016	84/50/84		1	7315885974098	5974090
CYB-DP Angled cover, 2 x Actassi 250 Cat 6 UTP, black mounting adaptors	White RAL 9016	84/50/84		1	7315880097563	5974095
	White RAL 9010				7315880104230	5974097
	Alu metallic Black				7315880104247 3606481069337	5974098 INS60704
CYB-DP Flat cover, 2 x Actassi 250 Cat 6 UTP, black mounting adaptors	White RAL 9016	84/27/84		1	7315880102489	5974096
	White RAL 9010				7315880104261	5974206
	Alu metallic				7315880104278	5974207
	White RAL 1013				7315880115779	5974208
Actassi 500 Cat 6 STP						
CYB-DP Angled cover, 2 x Actassi 500 Cat 6A STP, mounting plate and RJ connectors.	White RAL 9016 Alu metallic	84/50/84		1	3606481258250 3606481258267	INS60500 INS60501
CYB-DP Flat cover, 2 x Actassi 500 Cat 6A STP, mounting plate and RJ connectors.	White RAL 9016	84/27/84		1	3606481258274	INS60502
	Alu metallic				3606481258281	INS60503

L62560
L58880, L57190



P1940



P1928



P1930



Connection kits for wall mounting, including connectors

	Type	Colour	Dimensions A/B/C (mm)		Qty per package	EAN code	Ref. No.
L20980 L20990	Kit including wall mounting frame, label with label window, angled or flat cover, mounting plate, connector(s) and termination guide. Depending on the connector(s), the kits can be used for structured cabling networks for pair cables, general low voltage, coaxial or fibre connection. Material: PC/ABS.						
Duplex SC Multimode							
L52150 L54680	CYB-DF	White RAL 9016	84/40/84		1	7315880065968	5973105
	Angled cover, Duplex SC Multimode with two screws						
Actassi 125 Cat. 5e UTP							
L62560 L56890 L57190	CYB-DP	White RAL 9016	84/40/84		1	7315880075363	5973205
	Angled cover, 2 x Actassi 125 Cat. 5e UTP, 2 x black mounting adaptors						

Accessories for CYB

	Type	Colour	Dimensions A/B/C (mm)		Qty per package	EAN code	Ref. No.
Mounting frames, low voltage							
P64418	Mounting frame, low, with 60 mm front opening. To be screw-mounted on installation boxes c/c 60 mm. The mounting frame is also prepared for installation together with mini trunking type TMK-1020. Intended for low voltage mounting kits CYB-BK. Material: PC/ABS.						
	CYB-MF1L	White RAL 9016	90/23/90		1	7315885971165	5971160
P64408	Mounting frame, low, with 80 mm front opening. To be screw-mounted on installation boxes c/c 71 or 84 mm. The mounting frame is also prepared for installation together with mini trunking type TMK-1020. Intended for low voltage mounting kits CYB-BK and power-current mounting frame CYB-AD1. Material: PC/ABS.						
	CYB-MF2L	White RAL 9016	90/23/174		1	7315885971172	5971170
P64407	Mounting frame, high, with 80 mm front opening. To be screw-mounted on walls without installation boxes. Intended for low voltage mounting kits CYB-BK and power-current mounting frame CYB-AD1. Material: PC/ABS.						
	CYB-MF1H	White RAL 9016 White RAL 9010 Alu metallic	90/42/90		1	7315880095699 7315880095705 7315880104391	5971165 5971166 5971168
P64402	Mounting frame, high, with 100 mm front opening. To be screw-mounted on walls without installation boxes. Intended for low voltage mounting kits CYB-BK and power-current mounting frame CYB-AD1. Material: PC/ABS.						
	CYB-MF2H	White RAL 9016	90/42/174		1	7315880095729	5971175
Protective casing							
P1920	Protective casing to be mounted on the back of the mounting frame, for protection of data connectors and cable connections. Intended for low voltage mounting kits CYB-BK1 and -BK2. See also Compatibility on page 35. Material: PP.						
	CYB-RK	Red	63/38/63		10	7315885971202	5971200
Surface mounting frame							
P3716	Surface mounting frame, to be mounted on the wall together with low voltage mounting kits CYB-BK3 and CYB-BK4 to provide an extra height of 25 mm. Material: ASA.						
	CYB-RF	White RAL 9016	84/26.5/84		1	7315885971158	5971150
Indicating lamp							
P67390	Indicating lamp 0.9 mA intended for CYB power-current switches. Material: PA (casing).						
	CYB-GL2	—	16/25/39		5	7315880075134	5972105
Screw pillar							
P64403	Screw pillar for Phillips cross-slotted screw No. 1. Used to mount screw-fixed standard outlets c/c 60 mm. Intended for boxes CYB-S40 and CYB-D40. Material: PA6, 30% glass-fibre.						
	CYB-P3	Natural	11/43/10		20	7315880052265	5961506
Marking kit							
P136335	Marking kit including label window and label. Intended for CYB low voltage and single power current devices with a marking option. Material: PMMA.						
	CYB-LW2	—	12/67/4		10	7315885951365	5951365

Accessories for CYB

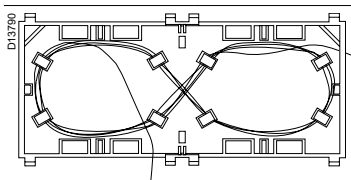
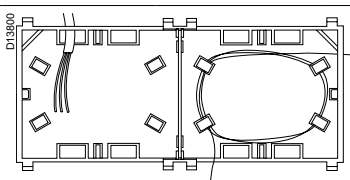
Type	Colour	Dimensions A/B/C (mm)	Qty per package	EAN code	Ref. No.
Protective casing for fibre optics					
Protective casing to be mounted in service carriers with front F80®, together with two CYB low-voltage connection or mounting kits. Also compatible with protective casing CYB-RK, low design. Including removable partition wall, which can be used to separate fibre and copper cables. Provided with eight cable exits on the long sides. There are also two cable exits on the short sides; one that is angled at 45°, to allow mounting of several casings next to each other, and one adapted to the BICC Brand-Rex Blolite system, including nipple. Bending radius >30 mm. A bending radius of 10 times the cable diameter is normally recommended, i.e. in this case a cable diameter of 3 mm at the most. CYB-DF allows installation to satisfy the preliminary standard EN50174-2. Material: PP.					
CYB-DF	White	79/39/168	10	7315885971226	5971220
					
Fibre capacity max. 4 m cable, diameter 0.9 mm, when using the entire coiling space.		Fibre capacity max. 2 m cable, diameter 0.9 mm, when using half the coiling space.			

CTA accessories for CYB

Dust cap					
Dust cap 2xRJ45, to be used in mounting plates for two connectors where only one connector has been mounted. Can also be used in conjunction with a connector. Suitable for mounting plates CYB, for modular connectors of Lucent Tech. M-type. Material: Thermoplastic.					
CTA-BP1	White	18/6/20	10	7315885914179	5914170
Blanking plug					
Blanking plug 2xRJ45, to be used in mounting plates for two connectors where only one connector has been mounted. Suitable for mounting plates CYB, for modular connectors of AMP type. Material: PC/ABS.					
CTA-BP2	Black	21/15/15	10	7315885914162	5914160

CYB-RK – Compatibility

CYB-RK protective casing cannot be mounted together with connectors marked “no” in the table below.

Connector type	CYB-RK high with mounting kit		CYB-RK low with mounting kit	
	BK1 angled	BK2 flat	BK1 angled	BK2 flat
Alcatel	yes	yes	yes	no
AMP 2x8-position modular jack UTP	yes	yes	yes	no
AMP 110 Con 2x8-position modular jack STP	yes	yes	yes	no
AMP 110 Con 2x8-position modular jack UTP	yes	yes	yes	no
AMP 1xSC duplex	yes	no	yes	no
1xBNC TNC	yes	yes	yes	no
2xBNC TNC	yes	yes	yes	no
1xDIN 3/8	yes	yes	yes	yes
2xDIN 3/8	yes	yes	yes	yes
1xD-sub 9	yes	yes	yes	yes
1xD-sub 15	yes	yes	yes	yes
1xD-sub 25	yes	yes	yes	no
1xEAE-1R, -1ER	yes	no	yes	no
2xEAE-2R, -2ER	yes	no	yes	no
1xF	yes	yes	yes	yes
2xF	yes	yes	yes	yes
IBM type 2 1xIBM	yes	yes	yes	no
IBM type 1 1xIBM + 1x8-position modular jack AMP	yes	yes	yes	no
ITT-Cannon	yes	yes	yes	yes
Actassi 125 UTP/STP	yes	yes	yes	no
Actassi 250 UTP/STP	yes	yes	yes	no
Lucent 2x8-position modular jack STP	yes	yes	yes	no
Lucent 2x8-position modular jack UTP	yes	yes	yes	no
R&M 1x8-position modular jack UTP	yes	yes	yes	no
R&M 2x8-position modular jack UTP	yes	yes	yes	no
R&M 1x8-position modular jack STP	yes	yes	yes	no
R&M 2x8-position modular jack STP	yes	yes	yes	no
R&M FreeNet 8-p modular	yes	yes	yes	no
Siemon Mx	yes	yes	yes	no
Siemon Mx duplex SC/SC	yes	no	yes	no
1xST	yes	no	yes	no
2xST	yes	no	yes	no
T&B 2x8-position modular jack STP	yes	yes	yes	no
T&B 2x8-position modular jack UTP	yes	yes	yes	no
Thinnet Tap AMP*	—	yes	—	no
2xTwinax	yes	yes	yes	yes
1xXLR	yes	yes	yes	yes

* Only flat mounting.



Description

The MIB system includes boxes and accessories, adapted to Thorsman service carriers with front cover F80®.

- MIB-A1 is a single installation box for devices with a c/c distance of 60 mm, MIB-A2 a double box for devices with a c/c distance of 71 mm. MIB-A1 and -A2 are also available in kits including two insulating pieces. These kits are called MIB-A1D3 and -A2D3 respectively.
- MIB-J is a junction box to be hooked onto the side of MIB-A1 and MIB-A2. This means that the junction box can be covered by a front cover piece to get a nice appearance (see fig. 1 to the left).
- MIB-FA1 is a frame adapted to CEE-outlets with c/c 60 mm hole distance. With label window.

Approvals

SEMKO, NEMKO, FIMKO, KEMA, VDE.

Material data

Material	PC/ABS
Colour, boxes	White
Colour spec., frame	White RAL 9016
Material	PA6
Fire rating	UL 94 V-2 (halogen-free)
Colour	White

Operative data



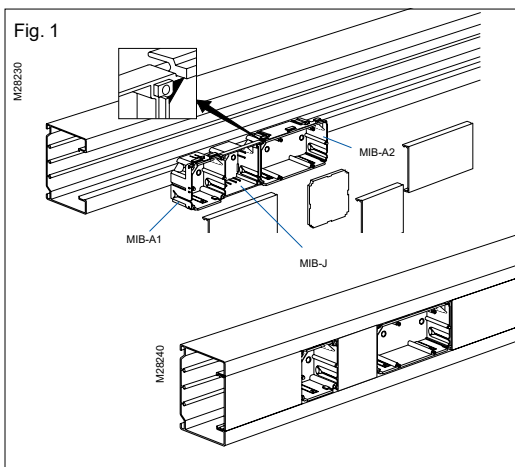

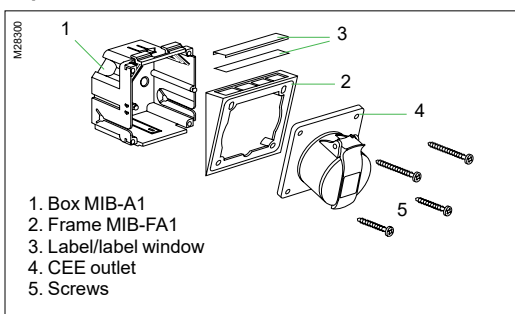

Suitable outdoors	No
Degree of protection	IP20



Exploded view



MIB Boxes & accessories

Type	Colour	Dimensions A/B/C (mm)	Qty per package	EAN code	Ref. No.
Installation boxes					
Single and double installation box including strain relief devices. Intended for mounting of standard devices in service carriers with front F80. Can be combined with junction box MIB-J. Material: PC/ABS.					
P61512 	White	79/45/71	10	7315885586154	5586150
P61511 	White	79/45/142	5	7315880079798	5586155
Installation box kits					
Installation box kit including single or double installation box MIB-A1 with strain relief devices and two insulating pieces MIB-D3. Intended for mounting of standard devices in service carriers with front F80. Can be combined with junction box MIB-J. Material: PC/ABS.					
P150152 	White	79/45/77.5	10	7315880113805	5586152
P150344 	White	79/45/148.5	5	7315880114833	5586157
Junction box					
Junction box with cover, intended for mounting in combination with installation boxes MIB-A1 and MIB-A2. Material: PA6.					
P61522 	White/red	71/40/93	10	7315885586161	5586160
Frame					
Frame with label window, intended for CEE devices with a c/c distance of 60 mm. To be mounted in MIB-A1 by means of four included screws. Material: PC/ABS.					
P61426 	White RAL 9016	84/84/23	1	7315880090557	5586211

Mini- trunking

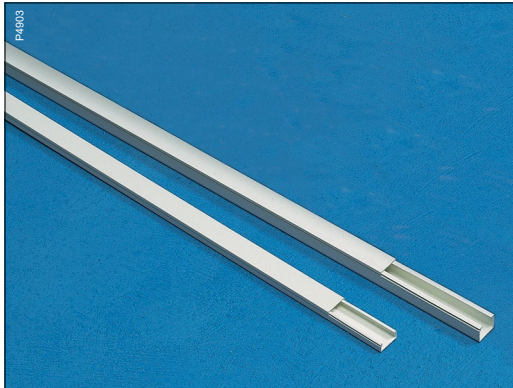

Description

The halogen-free TMK range includes halogen-free mini-trunking for very quick and easy, concealed installation of cables and wiring.

The halogen-free material provides excellent mechanical properties and resistance to UV light. In case of a fire no hydrogen-chloride gases, forming hydrochloric acid in contact with water, is given off. The TMK mini-trunking is therefore well suited for hospitals, computer centres, control rooms, etc. The back section of the mini-trunking is provided with pre-punched holes at c/c 100 mm centres, for fast installation with for instance nail-plugs TPS 4/5x25 directly to the surface. The cover is then snap-fitted to the trunking base (back section).

For low voltage cabling, TMK can also be fixed with adhesive; good bonding is ensured by the ribbing on the back.

External/internal corners and 90° bends, providing a bending radius of 35 mm for Ø7 mm cables, are available in the range, as well as stop ends and junction boxes.

Mounting instruction

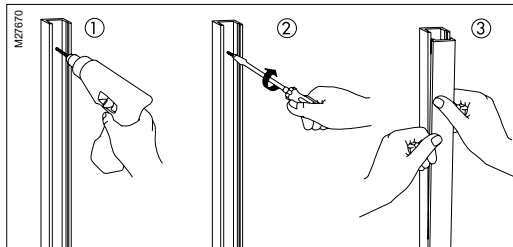

Design and dimensions

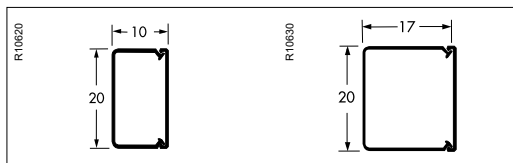

Material data

Material	PC/ABS, halogen-free, flame retardant
Resistance to impact	2 Nm
Colour spec.	White RAL 9010
Material	ABS
Colour spec.	White RAL 9010

Cable capacity

Comp.	Comp. height (internal)	Cross section area mm ²	Cable capacity mm ²			
			40%	50%	60%	
TMK 10x20 mm 1	7	155	62	78	93	
TMK 17x20 mm 1	10	270	108	135	162	

Range TMK Mini-trunking

Type	Colour	Dimensions A/B/C (mm)	Qty per package	EAN code	Ref. No.
Halogen-free mini-trunking for power and low voltage cables and wiring. Base section with pre-punched holes for fixing. Back of base section ribbed for fixing with adhesive (only for low voltage applications). Corners and bends give 35 mm bending radius for Ø7 mm cable. Material: PC/ABS (base and cover). ABS (corners, bends, stop ends, junction boxes).					
Mini-trunking (trunking base with cover)					
TMK-T20 10 mm	White	20/10/2500	50 m	7315885400115	5400110
TMK-T20 17 mm	White	20/17/2500		7315885400122	5400120
Internal corners					
TMK-IH1020	White	22.5/55/55	10	7315880097631	5401011
TMK-IH1720	White	22.5/61/61	10	7315880097624	5401021
External corners					
TMK-YH1020	White	22.5/55/55	10	7315880097594	5401111
TMK-YH1720	White	22.5/55/55	10	7315880097587	5401121
Bends, 90°					
TMK-LS1020	White	55/11/55	10	7315880097617	5401211
TMK-LS1720	White	55/17.5/55	10	7315880097600	5401221
Stop ends					
TMK-ES1020	White	22/11.5/11	10	7315880097655	5401311
TMK-ES1720	White	22/11.5/18	10	7315880097648	5401321
Junction box					
TMK-AD70	White	25/71/71	10	7315885402010	5402010
For junctions and wall penetrations					

PR2852
PR2840



PR2860



PR2861



PR2856



PR2857



PR2853



PR2854



PR2866



PR2867



PR2864



Cable
distribution
trunking

Feeder trunking system

Type	Colour	Dimensions A/B/C mm	Qty per package	EAN code	Ref. No.
------	--------	---------------------	-----------------	----------	----------

Feeder trunking system including trunking profile with cover, corner sections, 90° bends and stop ends in five sizes. The two smallest sizes (5630 and 7640) have two compartments, 10134 has three and the two larger sizes (12334 and 16155) four compartments. The range also includes a jointing piece and a cable tie holder.

Material: Aluminium SS 4104
 Surface treatment: Natural anodizing or powder coating in white or acc. to the Colour Choice
 Colour spec.: White RAL 9016

Design and Dimensions

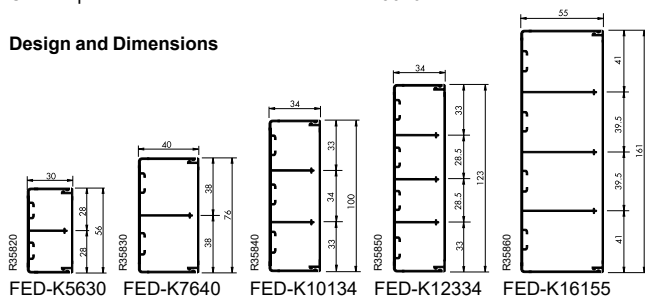

Cable capacity







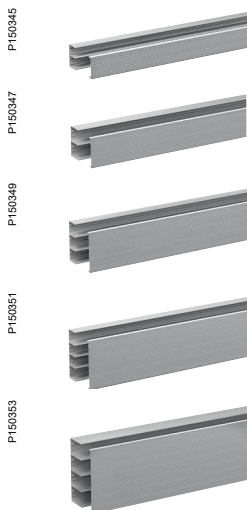

Comp. No.	Max Ø mm	Cross-section area mm ²	Cable capacity mm ²			Diagram
			40%	50%	60%	
1	26	584	234	292	350	
2	26	584	234	292	350	
1	36	1184	474	592	710	
2	36	1184	474	592	710	
1	31	821	328	411	493	
2	33	866	346	433	520	
3	31	821	328	411	493	
1	31	820	328	410	492	
2	27	711	284	356	427	
3	27	711	284	356	427	
4	31	820	328	410	492	
1	38	1838	735	919	1103	
2	38	1806	722	903	1084	
3	38	1806	722	903	1084	
4	38	1838	735	919	1103	

Feeder trunking

FED-K5630	Natural White RAL 9016	56/30/2500	8	7315885435100 7315880004943	5435100 5435108
FED-K7640	Natural White RAL 9016	76/40/2500	6	7315885435117 7315880004967	5435110 5435118
FED-K10134	Natural White RAL 9016	100/34/2500	6	7315885435124 7315880004981	5435120 5435128
FED-K12334	Natural White RAL 9016	123/34/2500	4	7315885435131 7315880005001	5435130 5435138
FED-K16155	Natural White RAL 9016	161/55/2500	2	7315885435148 7315880005025	5435140 5435148



Feeder trunking system

Type	Colour	Dimensions A/B/C mm		Qty per package	EAN code	Ref. No.
Internal corner						
FED-IH5630	Natural	56/30/220		1	7315885440104	5440100
	White RAL 9016				7315880005094	5440108
FED-IH7640	Natural	76/40/220		1	7315885440111	5440110
	White RAL 9016				7315880005117	5440118
FED-IH10134	Natural	100/34/220		1	7315885440128	5440120
	White RAL 9016				7315880005131	5440128
FED-IH12334	Natural	123/34/220		1	7315885440135	5440130
	White RAL 9016				7315880005155	5440138
FED-IH16155	Natural	161/55/220		1	7315885440142	5440140
	White RAL 9016				7315880005179	5440148
External corner						
FED-YH5630	Natural	56/30/220		1	7315885440203	5440200
	White RAL 9016				7315880005193	5440208
FED-YH7640	Natural	76/40/220		1	7315885440210	5440210
	White RAL 9016				7315880005216	5440218
FED-YH10134	Natural	100/34/220		1	7315885440227	5440220
	White RAL 9016				7315880005230	5440228
FED-YH12334	Natural	123/34/220		1	7315885440234	5440230
	White RAL 9016				7315880005254	5440238
FED-YH16155	Natural	161/55/220		1	7315885440241	5440240
	White RAL 9016				7315880005278	5440248
Bend, 90°						
FED-LS5630	Natural	56/30/220		1	7315885440302	5440300
	White RAL 9016				7315880005292	5440308
FED-LS7640	Natural	76/40/220		1	7315885440319	5440310
	White RAL 9016				7315880005315	5440318
FED-LS10134	Natural	100/34/220		1	7315885440326	5440320
	White RAL 9016				7315880005339	5440328
FED-LS12334	Natural	123/34/220		1	7315885440333	5440330
	White RAL 9016				7315880005353	5440338
FED-LS16155	Natural	161/55/220		1	7315885440340	5440340
	White RAL 9016				7315880005377	5440348
Stop end						
FED-ES5630	Natural	56/30/51		1	7315885440401	5440400
	White RAL 9016				7315880005391	5440408
FED-ES7640	Natural	76/40/51		1	7315885440418	5440410
	Optional				7315880005407	5440411
	White RAL 9016				7315880005414	5440418
FED-ES10134	Natural	101/34/51		1	7315885440425	5440420
	White RAL 9016				7315880005438	5440428
FED-ES12334	Natural	123/34/51		1	7315885440432	5440430
	White RAL 9016				7315880005452	5440438
FED-ES16155	Natural	161/55/23		1	7315885440449	5440440
	White RAL 9016				7315880005476	5440448

P150355

P150357

P150359

P150365

Feeder trunking system

	Type	Colour	Dimensions A/B/C mm		Qty per package	EAN code	Ref. No.
L11620	Jointing piece, Cable tie holder						
	FED-SSJ Jointing piece	Untreated	8/11/50		10	7315885440814	5440810
L377030	FED-FA Cable tie holder	Black	4/11/50		10	7315885440807	5440800

Compatible accessories

	Cable retainer		Clamp intended to hold cables in place in the feeder trunking. Material: PA.				
P62869 P62863	TTM-KL36	Black	9.5/36/25		10	7315885401617	5401610
	TTM-KL60	Black	10/60/25		10	7315885401624	5401620
	TTM-KL42	Black	12/42/14		10	7315880079668	5401615

FED feeder trunking

Description

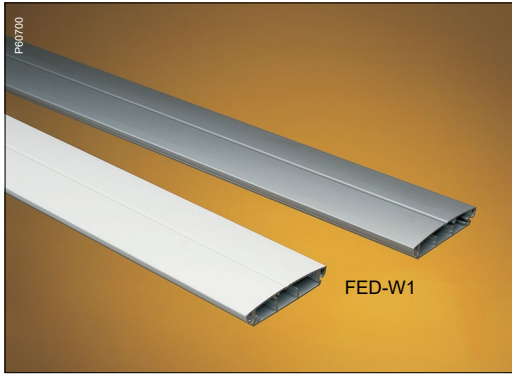

Description

FED-W1 and -F1 are slim feeder trunkings, specially designed for feeding of cables on walls and floors.

FED-W1

FED-W1 is intended for feeding of cables from the ceiling to wall service pole POL-W1. However, FED-W1 is suitable in all applications on walls where surface-mounted slim feeding of a smaller amount of cables is required.

FED-W1 is divided into three separate compartments by partition walls.

The trunking part can be completed by ceiling frame FED-CF1, to cover the entry hole when FED-W1 is led through a false ceiling.

FED-W1 is compatible with cable holder TTM-KL42, which can be used to keep cables in place in each compartment respectively. The cable holders are snap-fitted to the partition walls of the feeder trunking.

FED-F1

FED-F1 is intended for feeding of cables on the floor, to for instance a service post. FED-F1 is suitable in applications on floors where surface-mounted slim feeding of a smaller amount of cables is required.

FED-F1 is divided into three separate compartments by partition walls.

Material data

Feeder profile and cover	Material	Aluminium SS 4104
	Surface treatment	Natural anodizing or powder coating in white or acc. to the Colour Choice
	Colour spec.	White RAL 9016
Ceiling frame	Material	Polystyrene
	Colour spec.	White RAL 9016
	Other info	Halogen-free

Design & dimensions

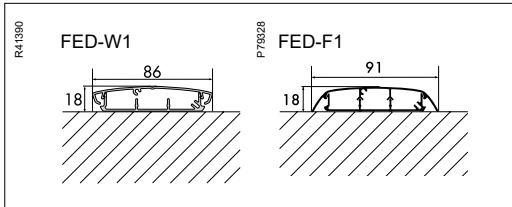

Cable capacity

Comp. No.	Max Ø mm	Cross section area mm ²	Cable capacity mm ²			Diagram
			40%	50%	60%	
FED-W1						
1	13	287	115	143	172	
2	14	313	125	156	188	
3	13	272	109	136	163	
FED-W1 with cable holder TTM-KL42						
1	11	208	83	104	125	
2	11	203	81	101	122	
3	13	272	109	136	163	
FED-F1						
1	13	287	115	144	172	
2	14	300	120	150	180	
3	13	276	110	138	166	

Feeder trunking

	Type	Colour	Dimensions A/B/C mm		Qty per package	EAN code	Ref. No.
PR2568	Feeder profile						
	Feeder profile including base profile and cover. Intended for wall mounting. The base profile has punched holes to simplify mounting. Divided into three compartments by two fixed partition walls and provided with screw slots for earth connection. Can be used as a separate item or in combination with wall service pole POL-W1. Cable holder TTM-KL42, Ref. No. 5401 615, can be used to keep cables in place. It is snap-fitted to the partition walls. Material: Aluminium, natural anodized or powder coated.						
PR2566	FED-W1	Natural White RAL 9016	18/86/2500		2	7315885435209 7315880079675	5435200 5435201
	Feeder profile including base profile and cover. Intended for floor mounting. The base profile has punched holes to simplify mounting. Divided into three compartments by two fixed partition walls and provided with screw slots for earth connection. Can be used as a separate item or in combination with POS-F10 and F20. Meets load requirements according to VDE 0634, 750N/50x50 mm2. Material: Aluminium, natural anodized.						
PR2569	FED-F1	Natural	18/91/2500		1	7315885435216	5435210
	Ceiling frame						
Ceiling frame to cover the entry hole when FED-W1 is led through a false ceiling. Material: Polystyrene.							
FED-CF1	White RAL 9016	1/116/33			1	7315885440821	5440820

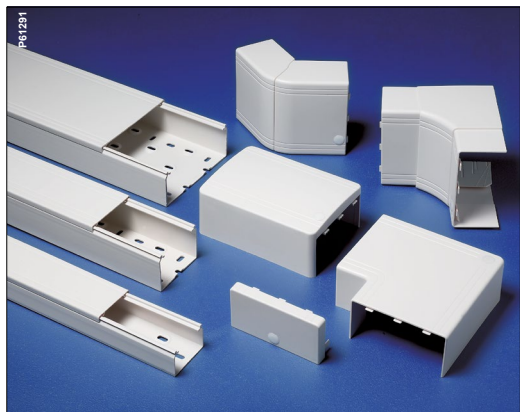

Description

TIR+ is a broad feeder trunking system intended for mounting in most environments. Mounting can be made horizontally or vertically.

The accessory range is extensive, which makes the system easy to work with.

The trunking can be divided into several compartments by means of cable shelves, for separation of power from low voltage cables.

The trunking back has holes according to DIN standard, for easy mounting of cable shelves and cable holders.

TIR+ is available in white colour and is supplied in lengths of 2500 mm.

Nail plug TPS is recommended for through mounting in concrete, lightweight concrete and bricks.

Length material

PE1290



Type	Colour	Dimensions A/B/C (mm)	Qty per package	EAN code	Ref. No.
------	--------	-----------------------	-----------------	----------	----------

Feeder trunking

Feeder trunking including trunking base and front cover. Holes according to DIN standard in the back of the trunking. Cable shelves and accessories to be mounted in the holes by means of fastener studs. Standard length 2.5 m. Material: PVC.

TIR+ T4040	White	40/40/2500	14	7315885427006	5427000
TIR+ T6040	White	60/40/2500	14	7315880103370	5427005
TIR+ T8040	White	80/40/2500	10	7315885427013	5427010
TIR+ T10040	White	100/40/2500	8	7315880103387	5427015
TIR+ T12040	White	120/40/2500	8	7315885427020	5427020
TIR+ T8060	White	80/60/2500	10	7314880103394	5427025
TIR+ T10060	White	100/60/2500	8	7315885427037	5427030
TIR+ T12060	White	120/60/2500	8	7315880103400	5427035
TIR+ T15060	White	150/60/2500	8	7315885427044	5427040
TIR+ T20060	White	200/60/2500	4	7315880103417	5427045

Front cover

Front cover to be used together with the trunking base. Standard length 2.5 m. Material: PVC.

PE1225

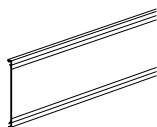

TIR+ L60	White	60/9/2500	20	7315880106531	5427305
TIR+ L80	White	80/10/2500	20	7315885427310	5427310
TIR+ L100	White	100/10/2500	16	7315880106548	5427315
TIR+ L120	White	120/10/2500	16	7315880106555	5427320

Kits

PE1290



Feeder trunking kit

Feeder trunking kit including trunking base, front cover and four cable clamps. Holes according to DIN standard in the back of the trunking. Cable shelves and accessories to be mounted in the holes by means of fastener studs. Standard length 2.5 m. Material: PVC.

TIR+ T6040KL	White	60/40/2500	14	7315885428003	5428000
TIR+ T8040KL	White	80/40/2500	10	7315880115199	5428005
TIR+ T10040KL	White	100/40/2500	8	7315885428010	5428010
TIR+ T8060KL	White	80/60/2500	10	7315885428027	5428020
TIR+ T10060KL	White	100/60/2500	8	7315880115212	5428025
TIR+ T12060KL	White	120/60/2500	8	7315885428034	5428030
TIR+ T15060KL	White	150/60/2500	8	7315880115229	5428035
TIR+ T20060KL	White	200/60/2500	4	7315885428041	5428040

Form pieces

PE1285



Internal corner

Internal corner section, adjustable 70–120°. Material: ABS.

TIR+ IH4040	White	44/100/42	1	7315885427051	5427050
TIR+ IH6040	White	64/100/42	1	7315880103424	5427055
TIR+ IH8040	White	84/100/42	1	7315885427068	5427060
TIR+ IH10040	White	105/100/43	1	7315880103431	5427065
TIR+ IH12040	White	125/100/43	1	7315885427075	5427070
TIR+ IH8060	White	84/135/62	1	7315880103448	5427075
TIR+ IH10060	White	105/155/63	1	7315885427082	5427080
TIR+ IH12060	White	125/155/63	1	7315880103455	5427085
TIR+ IH15060	White	155/155/63	1	7315885427099	5427090
TIR+ IH20060	White	205/155/63	1	7315880103462	5427095



Form pieces

Type	Colour	Dimensions A/B/C (mm)		Qty per package	EAN code	Ref. No.
External corner						
External corner section, adjustable 70–120°. Material: ABS.						
TIR+ YH4040	White	44/80/42		1	7315885427105	5427100
TIR+ YH6040	White	64/95/42		1	7315880103479	5427105
TIR+ YH8040	White	84/115/42		1	7315885427112	5427110
TIR+ YH10040	White	105/115/43		1	7315880103486	5427115
TIR+ YH12040	White	125/115/43		1	7315885427129	5427120
TIR+ YH8060	White	84/135/62		1	7315880103493	5427125
TIR+ YH10060	White	105/135/63		1	7315885427136	5427130
TIR+ YH12060	White	125/135/63		1	7315880103509	5427135
TIR+ YH15060	White	155/135/63		1	7315885427143	5427140
TIR+ YH20060	White	205/135/63		1	7315880103516	5427145
Bend, 90°						
90° bend to be used in angles. Material: ABS.						
TIR+ LS4040	White	44/70/42		5	7315885427150	5427150
TIR+ LS6040	White	64/100/42		2	7315880103523	5427155
TIR+ LS8040	White	84/130/42		2	7315885427167	5427160
TIR+ LS10040	White	105/150/43		1	7315880103530	5427165
TIR+ LS12040	White	125/170/43		1	7315885427174	5427170
TIR+ LS8060	White	84/130/62		2	7315880103547	5427175
TIR+ LS10060	White	105/150/63		1	7315885427181	5427180
TIR+ LS12060	White	125/170/63		1	7315880103554	5427185
TIR+ LS20060	White	205/250/63		1	7315880103561	5427195
T-piece						
T-piece to be used in 90° angles. The T-piece can be used for any trunking size that is smaller than the main feeder trunking in width. Material: ABS.						
TIR+ TS12040	White	130/56/180		1	7315885427266	5427260
TIR+ TS8060	White	90/73/132		2	7315880103639	5427265

Accessories

Stop end						
Stop end to finish the trunking. Material: ABS.						
TIR+ ES4040	White	45/42/16		5	7315885427204	5427200
TIR+ ES6040	White	65/42/16		30	7315880103578	5427205
TIR+ ES8040	White	85/42/16		30	7315885427211	5427210
TIR+ ES10040	White	105/42/16		20	7315880103585	5427215
TIR+ ES12040	White	125/42/16		20	7315885427228	5427220
TIR+ ES8060	White	85/62/16		20	7315880103592	5427225
TIR+ ES10060	White	105/62/16		20	7315885427235	5427230
TIR+ ES12060	White	125/62/16		20	7315880103608	5427235
TIR+ ES15060	White	155/62/16		10	7315885427242	5427240
TIR+ ES20060	White	205/62/16		10	7315880103615	5427245
Cable shelf						
Cable shelf to divide the trunking into compartments. Material: PVC.						
TIR-MV40	White	38/31/2500		24	7315880066514	5424015
TIR-MV60	White	38/51/2500		16	7315880066521	5424025

Accessories

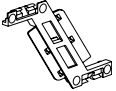
	Type	Colour	Dimensions A/B/C (mm)	 Qty per package	EAN code	Ref. No.	
	Fastener stud						
	Fastener stud for the mounting of cable shelves and cable holders in the holes of the trunking back. Material: PA.						
L13570		TIR-KP1	White	10/10/10	100	7315885424104	5424100
	Spacer						
	Spacer for the mounting of a smaller trunking size in a larger trunking size. Material: PA.						
L13620		TIR-D7,5	Grey	11.5/18/18	10	7315885424111	5424110
	Cable clamp						
	Cable clamp to keep the cables in place in the trunking. To be fixed in the front opening of the trunking. If needed, the clamp can also serve as an extra support for the cable shelf. Material: PA.						
P60853		TIR-KL80	Orange	68/10/96	25	7315880066545	5423435
		TIR-KL100	Orange	88/10/111	25	7315880066552	5423445
		TIR-KL120	Orange	108/10/117	25	7315880066569	5423455
		TIR-KL150	Orange	137/10/118	25	7315880066576	5423465

Exploded view

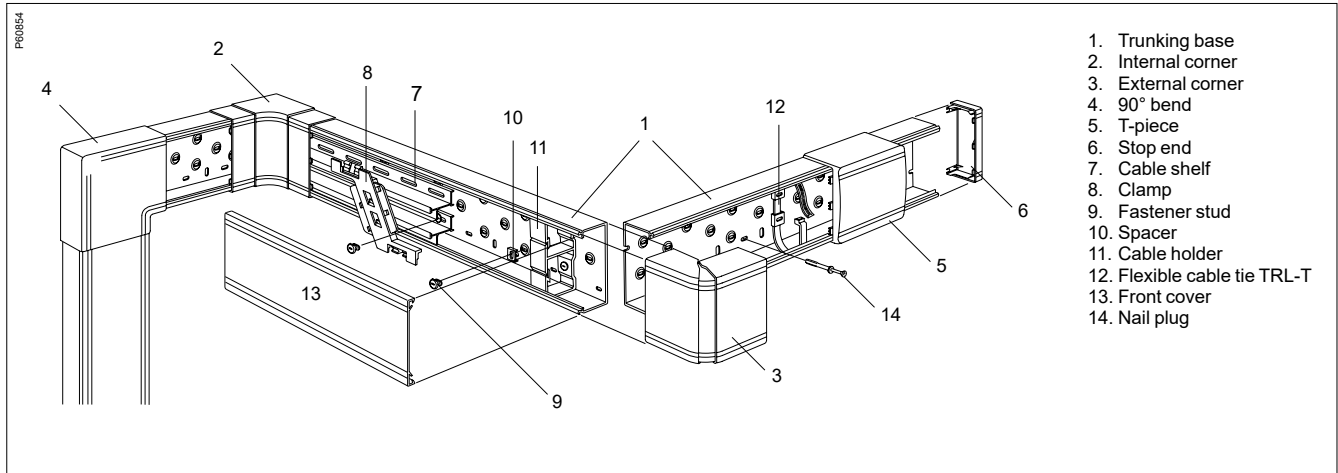

Design and dimensions

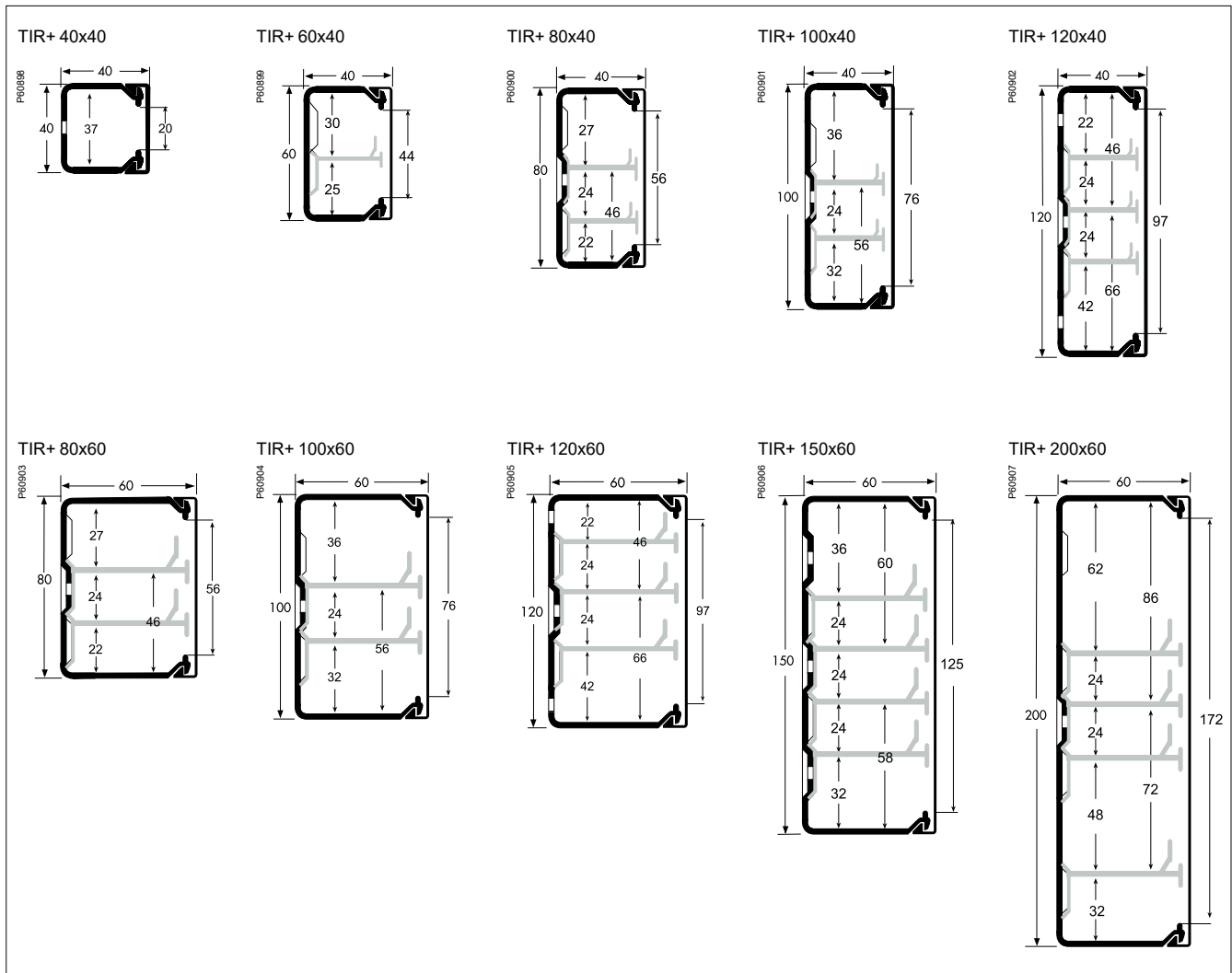

Cable capacity

Compartment No.	Cross section area mm ²	Cable capacity mm ²			Diagram	Compartment No.	Cross section area mm ²	Cable capacity mm ²			Diagram
		40%	50%	60%				40%	50%	60%	
TIR+ 40x40											
1	1370	548	685	822		1	4150	1660	2075	2490	
TIR+ 60x40											
1	1970	788	985	1182		1	5250	2100	2625	3150	
2	1370	548	685	822		2	1950	780	975	1170	
3	897	359	448	538		3	1950	780	975	1170	
4	708	283	354	425		4	1911	764	955	1146	
TIR+ 80x40											
1	2680	1072	1340	1608		1	6300	2520	3150	3780	
2	870	348	435	522		2	2490	996	1245	1494	
3	950	380	475	570		3	2490	996	1245	1494	
4	798	319	399	479		4	1105	442	552	663	
5	637	255	318	382		5	990	396	495	594	
6	591	236	295	355		6	990	396	495	594	
TIR+ 100x40											
1	3380	1352	1690	2028		1	7900	3160	3950	4740	
2	1140	456	570	684		2	3240	1296	1620	1944	
3	1140	456	570	684		3	3240	1296	1620	1944	
4	1160	464	580	696		4	1827	731	913	1096	
5	633	253	316	380		5	990	396	495	594	
6	947	379	473	568		6	990	396	495	594	
TIR+ 120x40											
1	4080	1632	2040	2448		1	10550	4220	5275	6330	
2	1420	568	710	852		2	1960	784	980	1176	
3	1420	568	710	852		3	2230	892	1115	1338	
4	653	261	326	392		4	2230	892	1115	1338	
5	520	208	260	312		5	1960	784	980	1176	
6	520	208	260	312		6	3211	1284	1605	1926	
7	1309	523	654	785		7	990	396	495	594	
TIR+ 80x60											
1	4150	1660	2075	2490		1	6300	2520	3150	3780	
2	1570	628	785	942		2	2490	996	1245	1494	
3	1510	604	755	906		3	2490	996	1245	1494	
4	1350	540	675	810		4	1105	442	552	663	
5	1107	443	553	664		5	990	396	495	594	
6	1029	411	514	617		6	990	396	495	594	
TIR+ 100x60											
1	5250	2100	2625	3150		1	7900	3160	3950	4740	
2	1950	780	975	1170		2	3240	1296	1620	1944	
3	1950	780	975	1170		3	3240	1296	1620	1944	
4	1911	764	955	1146		4	1827	731	913	1096	
5	1104	441	553	663		5	990	396	495	594	
6	1578	631	789	947		6	990	396	495	594	
TIR+ 120x60											
1	6300	2520	3150	3780		1	10550	4220	5275	6330	
2	2490	996	1245	1494		2	1960	784	980	1176	
3	2490	996	1245	1494		3	2230	892	1115	1338	
4	1105	442	552	663		4	2230	892	1115	1338	
5	990	396	495	594		5	1960	784	980	1176	
6	990	396	495	594		6	3211	1284	1605	1926	
7	2147	858	1073	1288		7	990	396	495	594	
TIR+ 150x60											
1	7900	3160	3950	4740		1	10550	4220	5275	6330	
2	3240	1296	1620	1944		2	1960	784	980	1176	
3	3240	1296	1620	1944		3	2230	892	1115	1338	
4	1827	731	913	1096		4	2230	892	1115	1338	
5	990	396	495	594		5	1960	784	980	1176	
6	990	396	495	594		6	3211	1284	1605	1926	
7	990	396	495	594		7	990	396	495	594	
8	1553	621	776	931		8	990	396	495	594	
TIR+ 200x60											
1	10550	4220	5275	6330		1	10550	4220	5275	6330	
2	1960	784	980	1176		2	1960	784	980	1176	
3	2230	892	1115	1338		3	2230	892	1115	1338	
4	2230	892	1115	1338		4	2230	892	1115	1338	
5	1960	784	980	1176		5	1960	784	980	1176	
6	3211	1284	1605	1926		6	3211	1284	1605	1926	
7	990	396	495	594		7	990	396	495	594	
8	990	396	495	594		8	990	396	495	594	
9	2210	884	1105	1326		9	2210	884	1105	1326	
10	1524	610	762	914		10	1524	610	762	914	

Standards

EN 50085.

Approvals

VDE, KEMA, NEMKO, SEMKO.

Material data

Feeder trunking base, front cover, cable shelf	Material	Rigid PVC, self-extinguishing, lead-free
	Fire rating	1.6 mm: UL94 V0 3.2 mm: UL94 V0
Corner sections, 90° bend, T-piece, stop end, jointing piece, mounting bracket	Material	ABS
	Fire rating	1.6 mm: UL94 HB 3.2 mm: UL94 HB
Fastener stud, spacer, clamp, cable holder	Material	PA6
	Fire rating	1.6 mm: UL94 V2 3.2 mm: UL94 V2
Collar	Material	PC/ABS
	Fire rating	UL 94 V-0 (1.6 mm halogen-free)
Colour spec.	White RAL 9010	

Operative data

Temperature range	From -25°C to +60°C
Degree of protection	IP40
Resistance to impact	6 J
Restrictions	Not resistant to acetone, thinners, trichlorethylene, ethyl acetate, methylenechloride, methyldethylketone, tetrahydrofuran, benzene and toluene

Pipe- and cable trunking

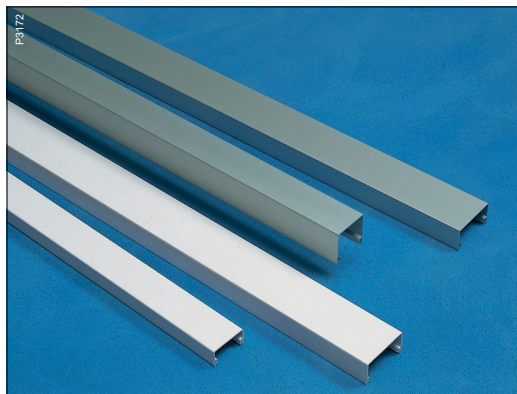

Description

The TRL range includes pipe and cable trunking made of rigid PVC or aluminium. The products are used to conceal heating pipes, wiring and cables. The TRL trunking comes in the form of a cover that is fixed to the base material by base clamps. Pipes, cables, etc. are fixed to the base clamps by self-locking ties, for a quick, stable and attractive installation. The cover is available in several sizes.

Installation

For vertical pipe installations it is best to screw the upper base clamp into place first, then the lower base clamp. The other base clamps can easily be inserted under the cables or pipes when they have been installed.

For joints and junctions, use the jointing piece. For extra secure locking of the cover when installed in highly exposed surroundings, use the clamp.

When going through for instance a floor between storeys of a building, use a collar and collar seal to cover and effectively seal the hole. When removing the cover, grip the upper or lower part of the cover and pull straight out.

Design and dimensions

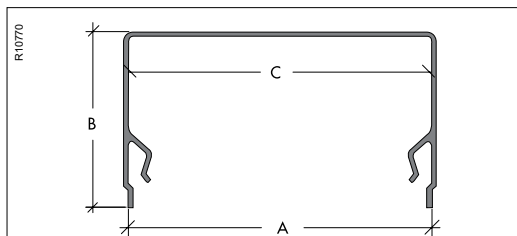

Type	A	B	C
TRL-D5630	56	30	53.5
TRL-D5656	56	56	53.5
TRL-D7640	76	40	73.5

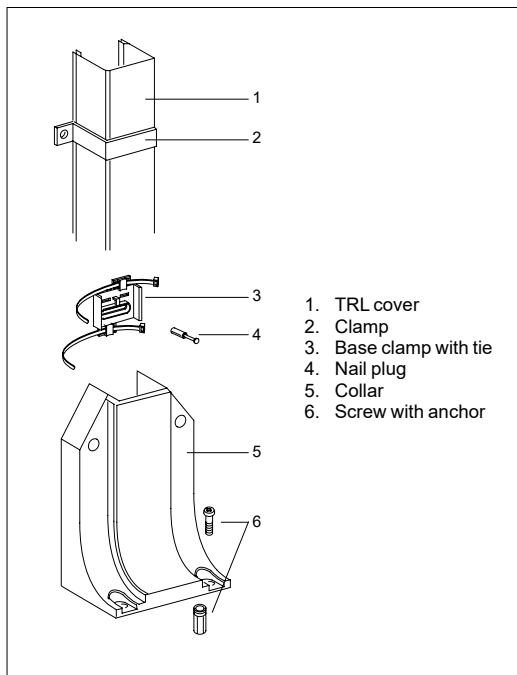

Benefits

- The base clamp is designed to be used with plumbing and electrical installations – a wide range of applications
- Snap-on fitting and self-locking ties for very quick and easy installation
- Base clamps with ties fix cables and pipes, while the cover simply conceals the installation
- Cables and pipes can be installed at an early stage
- No risk of damage to the cover, since it can be snap-fitted at a late stage in the building project

Material data

Material cover	PVC, rigid, self-extinguishing
Colour spec.	White RAL 9016
Material cover	Aluminium, natural anodized
Material accessories	PA (Polyamide)
Colour spec.	Black NCS 9500
	ABS (Acrylonitrile-butadiene-styrene)
Colour spec.	White RAL 9016
	Grey NCS 3502-Y
	PC/ABS (Polycarbonate/ABS)
Colour spec.	White RAL 9016
	Grey NCS 3502-Y
	PE (Polyethylene)
Colour spec.	Black NCS 9500
Temperature range PVC	-20°C to +60°C

Cable capacity

Type	No. of cables (with existing ties)			
	Ø 7	Ø 10	Ø 12	Ø 14
TRL-D5630	14	6	4	3
TRL-D5656	23	10	8	5
TRL-D7640	25	12	9	6

Pipe capacity

Type	Pipe diameter	No. of pipes
TRL-D5656	16 mm with compression coupling	2
	22 mm with solder coupling	2
TRL-D7640	22 mm with compression coupling	2
	28 mm with solder coupling	2

Heating pipes with a temperature of up to +85°C can be run in the cover. If the outside temperature of the pipes is more than +65°C, there should always be an air gap between the pipes and the inside of the cover.

Range TRL

	Type	Colour	Dimensions A/B/C (mm)		Qty per package	EAN code	Ref. No.
	Cover						
	Cover to be mounted on base clamps. Material: Aluminium (anodized) or PVC (white).						
P150229	TRL-D5630	Aluminium, natural PVC, white	56/30/2500		10	7315885321106 7315885320109	5321100 5320100
	TRL-D7640	PVC, white	76/40/2500		10	7315885320215	5320210
	Base clamp with ties						
	Base clamp with ties intended to fix cables and to attach the cover to the wall or other base material. The clamp is screw-fixed to the base surface. Material: PA.						
P150231	TRL-H56	Black	55/6/52		50	7315885322011	5322010
	TRL-H76	Black	72/8/56		100	7315885322028	5322020
	Stop ends						
	Stop end to be used for the termination of the TRL covers. Material: ABS.						
P150232	TRL-ES5630	White	60/31/30		100	7315885322110	5322110
	Collars						
	Collar to be fitted where TRL covers pass through floors and ceilings. Material: PC/ABS.						
P150236	TRL-KN5630	White	159/88/110		1	7315885322417	5322410
	TRL-KN5656	White	159/88/110		1	7315885322424	5322420
	Cover TML						
	Cover to be clipped on TTK clamps. Material: PVC (white).						
P150228	TML-TT20	PVC, white	20/16/2550		20	7315885000018	5000013

VDI devices

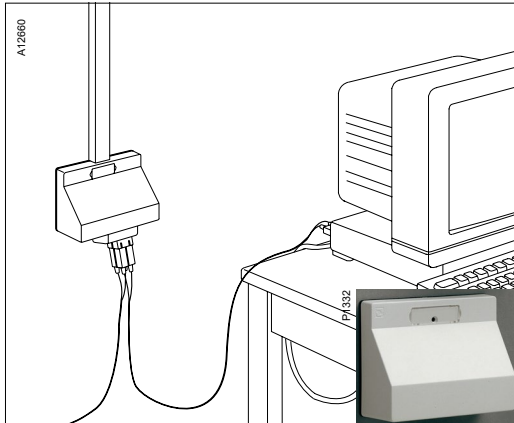

Description TDL-OP

TDL-OP offers a solution for workstations with fibre optic installations. It is suitable for either mounting on a box with 60 mm centres, directly onto a wall supplied from for instance a mini-trunking, or in service carriers with front F80, in which case adaptor TDL-F80 is required. An exception in the latter case are vertical service carriers that are "thinner" than 100 mm.

The cover is provided with a label window including label as well as a locking screw to fasten the cover.

Technical and Material data

Cover, mounting plate	Material	ABS (Acrylonitrile butadiene styrene)
	Fire rating	UL94 (1.47 mm) HB
	Colour spec.	White RAL 9016
Mounting frame, mechanical splice holder	Material	PA6 (Polyamide), reinforced, 30% glass fibre
	Fire rating	UL94 (0.79 mm) HB
	Colour	Black
Label window, label	Material window	PMMA (Polymethyl-metha-acrylate)
	Colour	Transparent
	Material label	Paper
Cable ties	Material	PA 6.6 (Polyamide)
	Colour	Natural
Locking screw	Material	Electroplated steel
Temperature range	From +5°C to +40°C	
Suitable outdoors	Not suitable	
Cable capacity	Approximately 4 metres of 0.9 mm fibre optic cable.	
Standards	ANSI X3T9.5 (FDDI).	

Exploded view

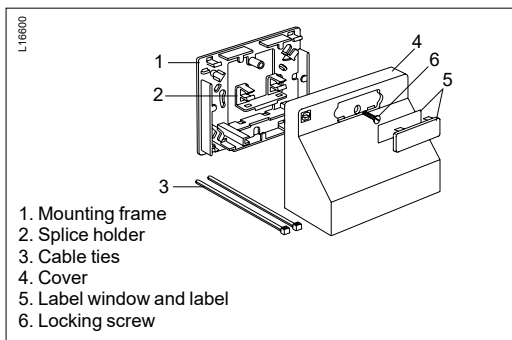

Design and dimensions

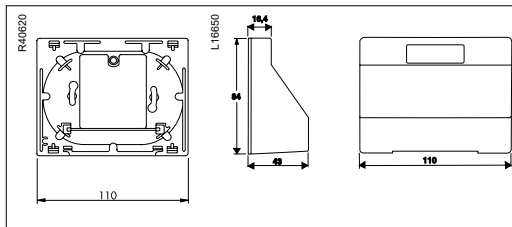

Range

Type	Colour	Dimensions A/B/C (mm)	Qty per package	EAN code	Ref. No.
Mounting kit					
Mounting kit including cover, mounting frame, mechanical splice holder, cable ties, label window with label and locking screw. Suitable for mounting on a box with 60 mm centres, in products with front F80 (exception, see above) by using adaptor TDL-F80 or directly on a wall. Intended for workstations with fibre optic installations. Material: ABS, PA6, PMMA, steel.					
TDL-OP	White	84/43/110	1	7315885917002	5917000



Description TDL-80/80H

Mounting kits type TDL can be used on boxes with screw holes at 60 mm centres, directly on a wall or in products with 80 mm front. When mounted in an 80 mm front adaptor TDL-F80 is required.

In vertical service carriers, mounting must be made in a CYB-S40 or MIB box in order to get a correct position of the TDL cover. This is also recommended for service posts type POS-200, where the door can make the bending radius too narrow.

The mounting kits include a strain relief brace provided with cable tie.

The TDL mounting kit is available in two designs, TDL- 80 and TDL-80H (high). Mounting plates and cover are fitted without tools.

The products are intended for structured cable systems.

Technical and Material data

Cover	Material	ABS (Acrylonitrile butadiene styrene)
	Fire rating	UL94 (1.47 mm) HB
	Colour	White RAL 9016
Base plate, mounting plate, strain relief brace, mounting adaptor	Material	PA 6 (Polyamide), 30% glass fibre reinforced
	Fire rating	UL94 (0.79 mm) HB
	Colour	Black
Cable tie (included in strain relief)	Material	PA 6.6 (Polyamide)
	Colour	Natural

Operative data

Temperature range	From +5°C to +40°C
Suitable outdoors	Not suitable

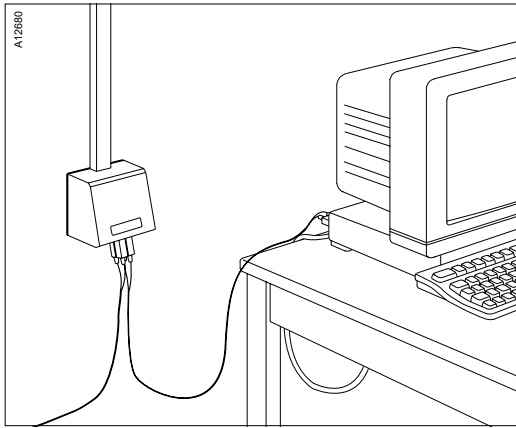



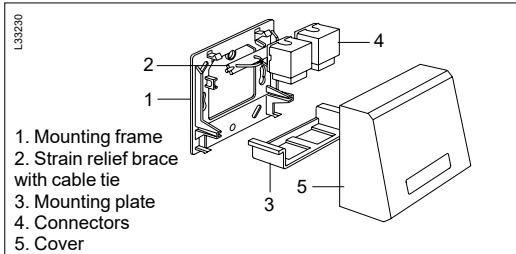



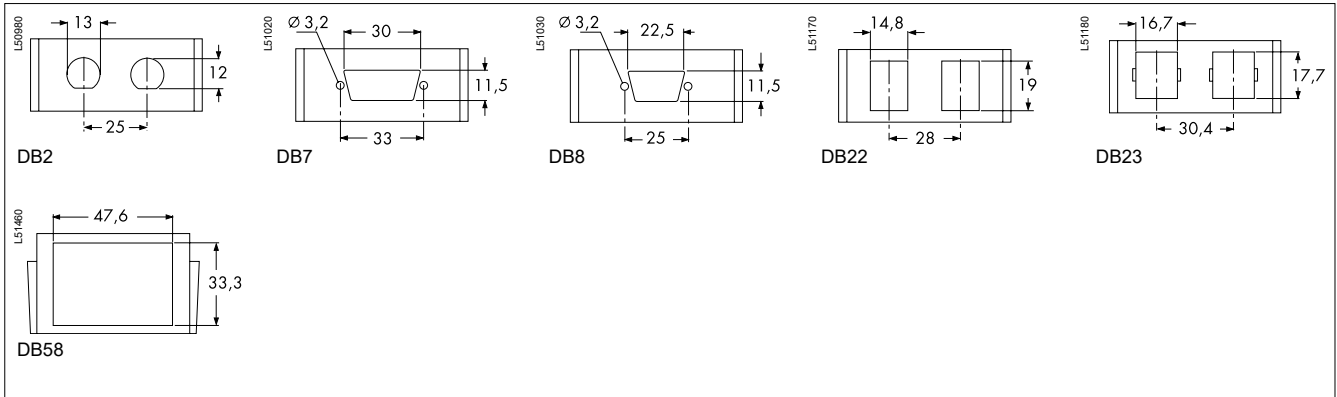

Exploded view



Design and dimensions of mounting plates



Mounting kits, accessories

Type	Colour	Dimensions A/B/C (mm)	Qty per package	EAN code	Ref. No.
Mounting kits					
Mounting kit, low, including cover, base plate and strain relief brace. The base plate is provided with holes for c/c 60 mm fixing to a box. Intended for surface mounting on a wall or on a c/c 60 box, or in a service carrier with 80 mm front. Material: PA (base plate), ABS (cover).					
	White	80/37/80	1	7315885910119	5910110
Mounting adaptor					
Mounting adaptor for TDL-80 and TDL-80H, to be used for installation trunking with 80 mm front. Snap-fitted to the front opening of the trunking. The mounting kit TDL-80/80H is then snapped onto the mounting adaptor. Material: PA, glass-fibre reinforced.					
	Black	80/28/80	10	7315885912052	5912050
Mounting frame					
Mounting frame for TDL-80 and TDL-80H, to be used for surface mounting for instance on a wall in combination with mini-trunking. The mounting kit TDL-80/80H is snapped onto the mounting frame. Material: PVC.					
	White	85/23/80	10	7315885912014	5912010
Mounting plates					
Mounting plate for various connectors, see below. Suitable for TDL-80, DB58 for TDL-80H, to be used in structured cable nets. Material: PA6, 30% glass-fibre.					
	Black	28/15/67	10	7315880016205	5910132
	Black	28/15/67	10	7315880016250	5910137
	Black	28/15/67	10	7315880022329	5910152
	Black	28/15/67	10	7315880022343	5910153
CTA accessories for TDL					
Dust cap					
Dust cap 2xRJ45, to be used in mounting plates for two connectors where only one connector has been mounted. Can also be used in conjunction with a connector. Suitable for mounting plates TDL, for modular connectors of Lucent Tech. M-type. Material: Thermoplastic.					
	White	18/6/20	10	7315885914179	5914170
Blanking plug					
Blanking plug 2xRJ45, to be used in mounting plates for two connectors where only one connector has been mounted. Suitable for mounting plates TDL, for modular connectors of AMP type. Material: PC/ABS.					
	Black	21/15/15	10	7315885914162	5914160

Cable organisers



Exploded view

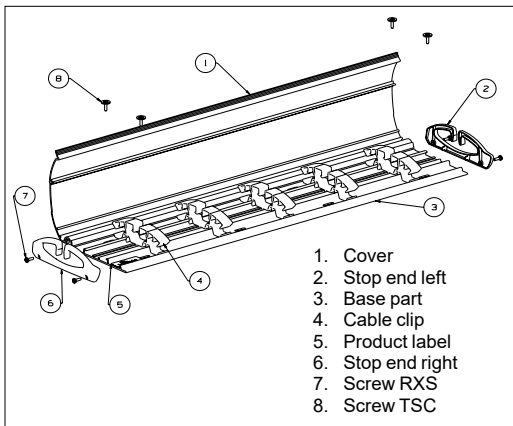

Design & dimensions

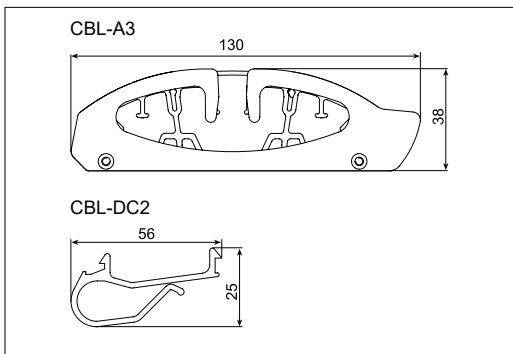

Cable capacity

Comp.	Max diam.	Cross section area mm ²	Cable capacity mm ²		
			40%	50%	60%
CBL-DC2					
1	13	333	133	167	200

Description CBL-A and -B

The covered cable organizer CBL-A3 can be mounted on the wall, under a desk, along the desk-edge or on the desk-top surface.

The aluminium profiles CBL-B2 and B3 are mounted on the wall or under the desk.

Shielding of electric fields

Measurements of electric fields have been made at an imaginary chair placed 0.5 m before CBL-A3 and on the floor under the chair.

1. At a standard-equipped work-place without CBL-A3 (cables hanging loose)
2. Same as above but with the cables fixed to the metal frame of the table by means of cable ties or the like
3. Same as above but with the cables inserted in an unshielded CBL-A3
4. Same as above but with the cables inserted in a shielded CBL-A3

Test No. (see above)	Alternating electric field at the chair (V/m)	Alternating electric field on the floor (V/m)
1.		42.6
2.		160.0
3.	49.3	63.4
4.	6.8	15.3
		2.6

Material and operative data

Material data	Material	Aluminium SS 4104
Cover and base part of CBL-A3, CBL-B2 and B3, CBL-DB50	Surface treatment	Natural anodizing 5–10 µm (CBL-A3, -B1, -B2 and -B3)
	Colour spec. CBL-A3	White RAL 9010, gloss 55
Operative data	Temperature range	From +60°C to -20°C
	Suitable outdoors	No
	Technical length of service	20 years
Material data	Sensitivity	Sensitive to strong acids and alkali
	Material	PP (polypropylene) with 20% glass-fibre
	Fire rating	UL 94 HB (halogen-free)
Operative data	Colour spec.	Greyish black NCS 7603- R74B
	Temperature range	From +80°C to -40°C
	Suitable outdoors	No
Material data	Technical length of service	20 years
	Sensitivity	Sensitive to strong acids and alkali
	Material	ASA
Operative data	Fire rating	UL 94 HB (halogen-free)
	Colour spec.	Greyish black NCS 7603-R74B
	Temperature range	From +80°C to -40°C
Operative data	Suitable outdoors	No
	Technical length of service	10 years
	Sensitivity	Sensitive to solvents

Patents & protection of design

Patents	CBL-A3 is protected by patent in Sweden and has a patent pending in Germany.
Protection of design	CBL-A3 has a protection of design in Sweden, Germany, Belgium, Holland and Luxembourg.



Description

CBL-G cable grommets are intended to feed cables through a desk-top.

Range

P64034



Type	Colour	Dimensions A/B/C mm		Qty per package	EAN code	Ref. No.
Cable grommet						
Cable grommet to be used to feed cables through the desk-top. Material: Zinc, chromium plated.						
CBL-G1	Alum. metallic	24/Ø65		1	7315885873629	5873620
CBL-G2	Alum. metallic	24/Ø85		1	7315880111078	5873621

5000013.....	158	5427130.....	150	5440420.....	144	5514003.....	22	5583570.....	26, 41, 52, 63
5150770.....	92	5427135.....	150	5440428.....	144	5514100.....	23	5583572.....	26, 41, 52, 63
5197005.....	92	5427140.....	150	5440430.....	144	5514102.....	23	5583574.....	26, 41, 52, 63
5197055.....	92	5427145.....	150	5440438.....	144	5514103.....	23	5583576.....	26, 41, 52, 63
5197100.....	99	5427150.....	150	5440440.....	144	5514110.....	24	5583608.....	26, 41, 52, 63
5197104.....	99	5427155.....	150	5440448.....	144	5514113.....	24	5586150.....	136
5197250.....	92	5427160.....	150	5440800.....	145	5514160.....	25	5586152.....	136
5197550.....	101	5427165.....	150	5440810.....	145	5514161.....	25	5586155.....	136
5197560.....	101	5427170.....	150	5440820.....	147	5514170.....	25	5586157.....	136
5197565.....	101	5427175.....	150	5501052.....	40	5514173.....	25	5586160.....	136
5197750.....	101	5427180.....	150	5501602.....	40	5519080.....	22	5586211.....	136
5197755.....	101	5427185.....	150	5501650.....	41	5519082.....	22	5588101.....	62
5197785.....	102	5427195.....	150	5501652.....	41	5519084.....	22	5589150.....	23, 50
5197790.....	102	5427200.....	150	5504000.....	22	5522010.....	50	5589170.....	23, 50, 62
5197795.....	102	5427205.....	150	5504002.....	22	5522020.....	50	5589500.....	24, 51
5197820.....	101	5427210.....	150	5504003.....	22	5522029.....	50	5589520.....	24, 51, 62
5197825.....	101	5427215.....	150	5504100.....	23	5526010.....	50	5590000.....	28
5197830.....	101	5427220.....	150	5504102.....	23	5526019.....	50	5590002.....	28, 54
5197835.....	101	5427225.....	150	5504103.....	23	5526510.....	50	5590030.....	28
5197910.....	92, 95	5427230.....	150	5504110.....	23	5526519.....	50	5590032.....	28
5197915.....	99	5427235.....	150	5504112.....	23	5526520.....	50	5590033.....	28
5197920.....	92, 96	5427240.....	150	5504113.....	23	5526530.....	51	5590035.....	28
5198100.....	95, 96	5427245.....	150	5504123.....	24	5526539.....	51	5590036.....	28, 54
5198715.....	95	5427260.....	150	5504133.....	24	5532020.....	50	5590039.....	28
5198716.....	95	5427265.....	150	5504140.....	25	5532021.....	50	5590041.....	65
5198717.....	95	5427305.....	149	5504160.....	25	5532600.....	50	5590060.....	28
5198725.....	95	5427310.....	149	5504161.....	25	5532601.....	50	5590068.....	28
5198915.....	96	5427315.....	149	5504170.....	25	5532610.....	50	5590069.....	28
5198916.....	96	5427320.....	149	5504172.....	25	5532611.....	50	5590070.....	28
5198917.....	96	5428000.....	149	5504173.....	25	5532620.....	51	5590073.....	28
5198925.....	96	5428005.....	149	5506310.....	22	5532630.....	51	5590075.....	28, 54
5198926.....	96	5428010.....	149	5506318.....	22	5532631.....	51	5590090.....	28
5320100.....	158	5428020.....	149	5506319.....	22	5532640.....	51	5590092.....	28
5320210.....	158	5428025.....	149	5506610.....	23	5532650.....	51	5590093.....	28
5321100.....	158	5428030.....	149	5506614.....	23	5532665.....	51	5590110.....	29
5322010.....	158	5428035.....	149	5507000.....	22	5532666.....	51	5590112.....	29
5322020.....	158	5428040.....	149	5507002.....	22	5536011.....	62	5590115.....	55, 65
5322110.....	158	5435100.....	143	5507003.....	22	5536111.....	62	5590180.....	29, 43, 55
5322410.....	158	5435108.....	143	5507100.....	23	5536211.....	62	5590190.....	26
5322420.....	158	5435110.....	143	5507102.....	23	5536311.....	62	5590200.....	25
5400110.....	140	5435118.....	143	5507103.....	23	5536411.....	62	5590203.....	25
5400120.....	140	5435120.....	143	5507110.....	23	5575250.....	23	5590204.....	25
5401011.....	140	5435128.....	143	5507112.....	23	5575254.....	23	5590205.....	25
5401021.....	140	5435130.....	143	5507113.....	23	5575260.....	23	5590208.....	25
5401111.....	140	5435138.....	143	5507120.....	24	5575264.....	23	5590209.....	25
5401121.....	140	5435140.....	143	5507122.....	24	5575270.....	24	5590232.....	51
5401211.....	140	5435148.....	143	5507123.....	24	5575274.....	24	5590237.....	51, 65
5401221.....	140	5435200.....	147	5507140.....	25	5575280.....	25	5590238.....	65
5401311.....	140	5435201.....	147	5507142.....	25	5575284.....	25	5590260.....	26
5401321.....	140	5435210.....	147	5507143.....	25	5576100.....	50	5590264.....	26
5401610.....	145	5440100.....	144	5507160.....	25	5576101.....	50	5590265.....	26
5401615.....	77, 145	5440108.....	144	5507161.....	25	5576110.....	50	5590269.....	26
5401620.....	145	5440110.....	144	5507170.....	25	5576111.....	50	5590310.....	28, 53
5402010.....	140	5440118.....	144	5507172.....	25	5576120.....	51	5590311.....	28, 42, 64
5423435.....	151	5440120.....	144	5507173.....	25	5576121.....	51	5590312.....	28, 42
5423445.....	151	5440128.....	144	5507800.....	22	5576129.....	51	5590314.....	28, 42, 53
5423455.....	151	5440130.....	144	5507802.....	22	5576130.....	51	5590319.....	28, 42, 54
5423465.....	151	5440138.....	144	5510010.....	22	5576340.....	51	5590322.....	28, 54
5424100.....	151	5440140.....	144	5510012.....	22	5576349.....	51	5590340.....	28, 43, 54, 64
5424110.....	151	5440148.....	144	5510013.....	22	5580030.....	26	5590341.....	55
5427000.....	149	5440200.....	144	5510020.....	22	5580038.....	26	5590346.....	28, 43, 54, 64
5427005.....	149	5440208.....	144	5510022.....	22	5580039.....	26	5590410.....	30, 43, 55
5427010.....	149	5440210.....	144	5510023.....	22	5580060.....	26, 52	5590414.....	30, 43, 55
5427015.....	149	5440218.....	144	5510160.....	25	5580069.....	26, 52	5590424.....	27, 53, 64
5427020.....	149	5440220.....	144	5510161.....	25	5580080.....	26, 41	5590430.....	27, 42
5427025.....	149	5440228.....	144	5510170.....	25	5580088.....	26, 41, 52	5590431.....	27, 42, 53
5427030.....	149	5440230.....	144	5510172.....	25	5580089.....	26	5590439.....	27
5427035.....	149	5440238.....	144	5510173.....	25	5580900.....	26, 52	5590440.....	27, 42, 53, 64
5427040.....	149	5440240.....	144	5510200.....	23	5582716.....	40	5590453.....	27, 42, 53, 63
5427045.....	149	5440248.....	144	5510202.....	23	5583010.....	26, 41, 52, 63	5590456.....	27, 42, 53, 63
5427050.....	149	5440300.....	144	5510203.....	23	5583014.....	26, 41, 52, 63	5590480.....	27, 42
5427055.....	149	5440308.....	144	5510210.....	24	5583016.....	27, 41, 52, 63	5590481.....	27, 42, 53
5427060.....	149	5440310.....	144	5510212.....	24	5583018.....	27, 41, 52, 63	5590482.....	27, 53, 64
5427065.....	149	5440318.....	144	5510213.....	24	5583020.....	27, 41, 52, 63	5590483.....	27
5427070.....	149	5440320.....	144	5510220.....	24	5583022.....	27, 41, 52, 63	5590486.....	27, 42, 53, 64
5427075.....	149	5440328.....	144	5510222.....	24	5583024.....	27, 41, 52, 63	5590500.....	30, 43
5427080.....	149	5440330.....	144	5510223.....	24	5583026.....	27, 41, 52, 63	5590513.....	30, 43
5427085.....	149	5440338.....	144	5510230.....	24	5583034.....	27, 42, 53, 63	5590520.....	29, 43, 55, 65
5427090.....	149	5440340.....	144	5510233.....	24	5583036.....	27, 42, 53, 63	5590720.....	29, 54
5427100.....	150	5440348.....	144	5510242.....	25	5583038.....	27, 42, 53, 63	5590730.....	29
5427105.....	150	5440400.....	144	5510302.....	23	5583040.....	27, 42, 53, 63	5590740.....	29, 54, 64
5427110.....	150	5440408.....	144	5512410.....	22	5583042.....	27, 42, 53, 63	5590750.....	29
5427115.....	150	5440410.....	144	5512418.....	22	5583044.....	27, 42, 53, 63	5590760.....	29, 54
5427120.....	150	5440411.....	144	5514000.....	22	5583408.....	27, 42, 53, 64	5590770.....	29
5427125.....	150	5440418.....	144	5514002.....	22	5583410.....	27, 42, 53, 64	5591050.....	25

Life Is On

Schneider
Electric

Schneider Electric Industries SAS

35, rue Joseph Monier
CS 30323
92506 Rueil Malmaison Cedex
France

RCS Nanterre 954 503 439
Capital social 896 313 776 €
www.schneider-electric.com

09-2024

© 2024 - Schneider Electric. All Rights Reserved.
All trademarks are owned by Schneider Electric Industries SAS or its affiliated companies.
LSB03002EN-00

This document has been
printed on recycled paper

