

XTPFUUHP-DF

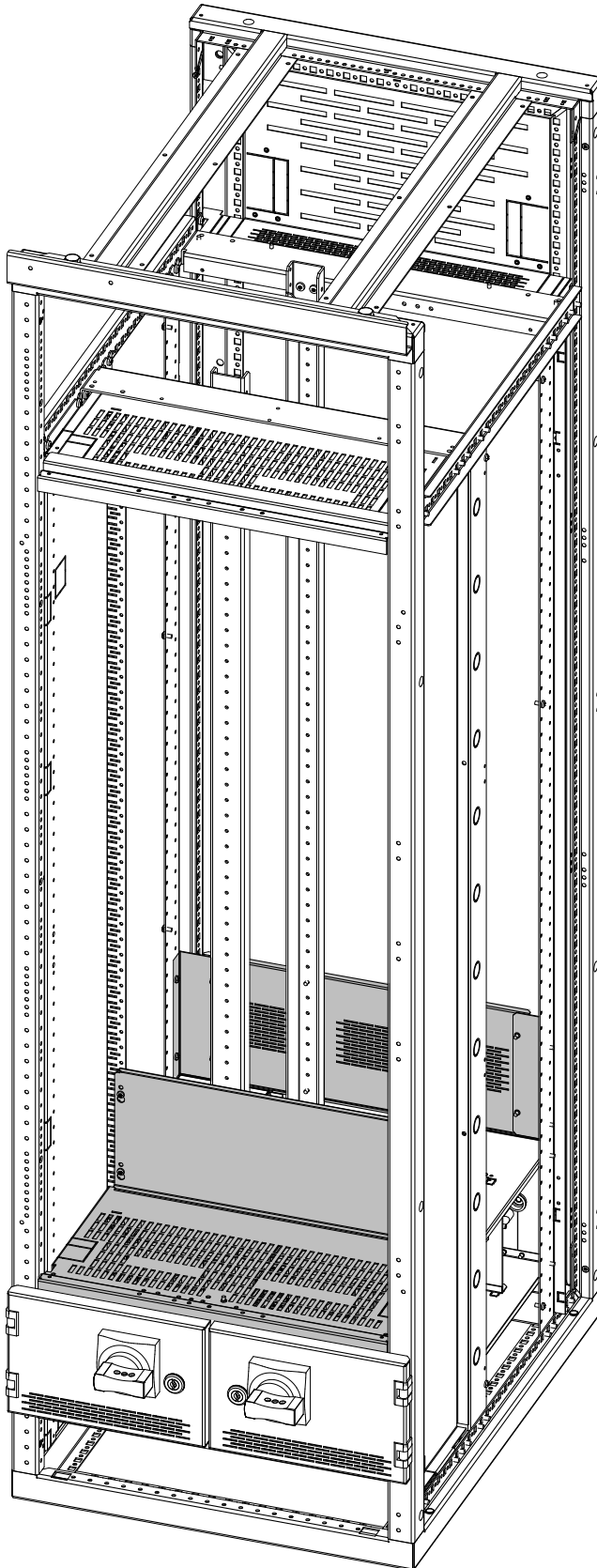







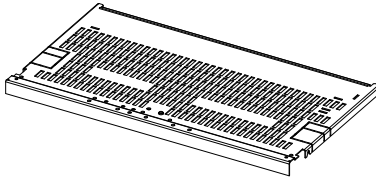
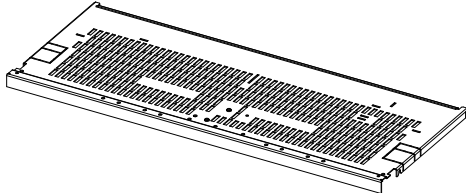

en Electric current! Danger to life!
Installation, commissioning and maintenance work must be carried out by qualified personnel only.

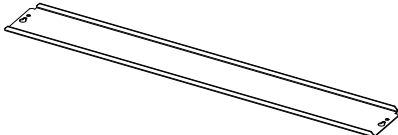
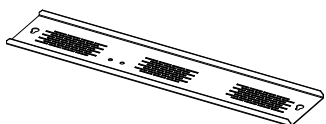
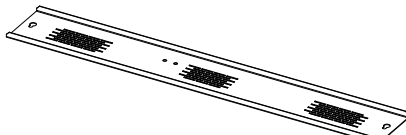
de Lebensgefahr durch elektrischen Strom!
Arbeiten bzw. Montage an diesem Produkt darf nur von Elektrofachkräften und elektrotechnisch unterwiesenen Personen ausgeführt werden.



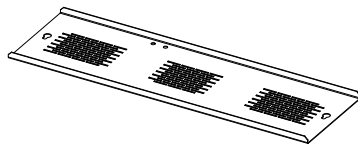
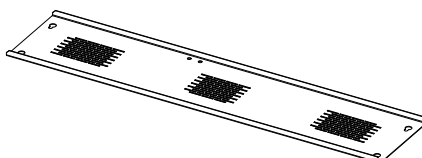
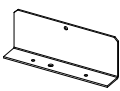



XTPFUUHP-DF Bill of material

Art. No.	Dim.	No	Part		Qty.
Included in all Article		1			1x
			W600	W800	
192923 192927	H100W600 H100W800	2			1x
		3			1x
		4			2x
		5		M5x10	9x
		192924 192928	H150W600 H150W800	2	
3			1x		
4			2x		
5		M5x10	12x		

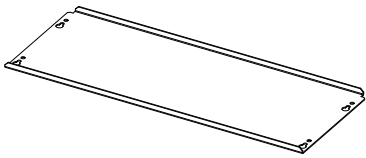
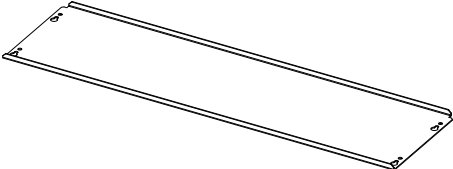
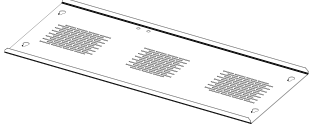
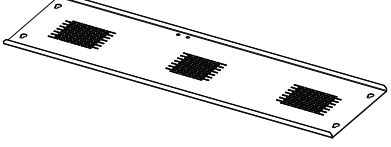
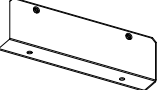

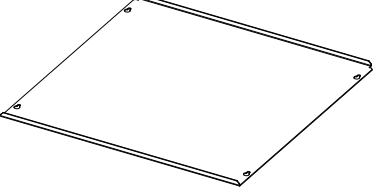
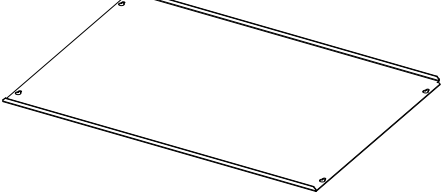
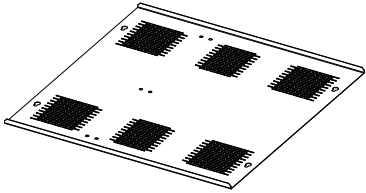
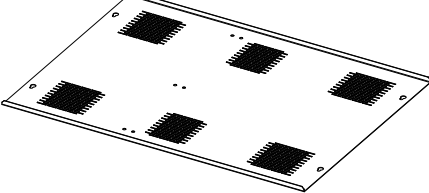
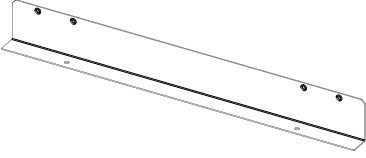
XTPFUUHP-DF Bill of material

Art. No.	Dim.	No	Part		Qty.
			W600	W800	
192925 192929	H200W600 H200W800	2			1x
		3			1x
		4			2x
		5		M5x10	16x
192926 192930	H500W600 H500W800	2			1x
		3			1x
		4			2x
		5		M5x10	17x

XTPFUUHP-DF

step 1

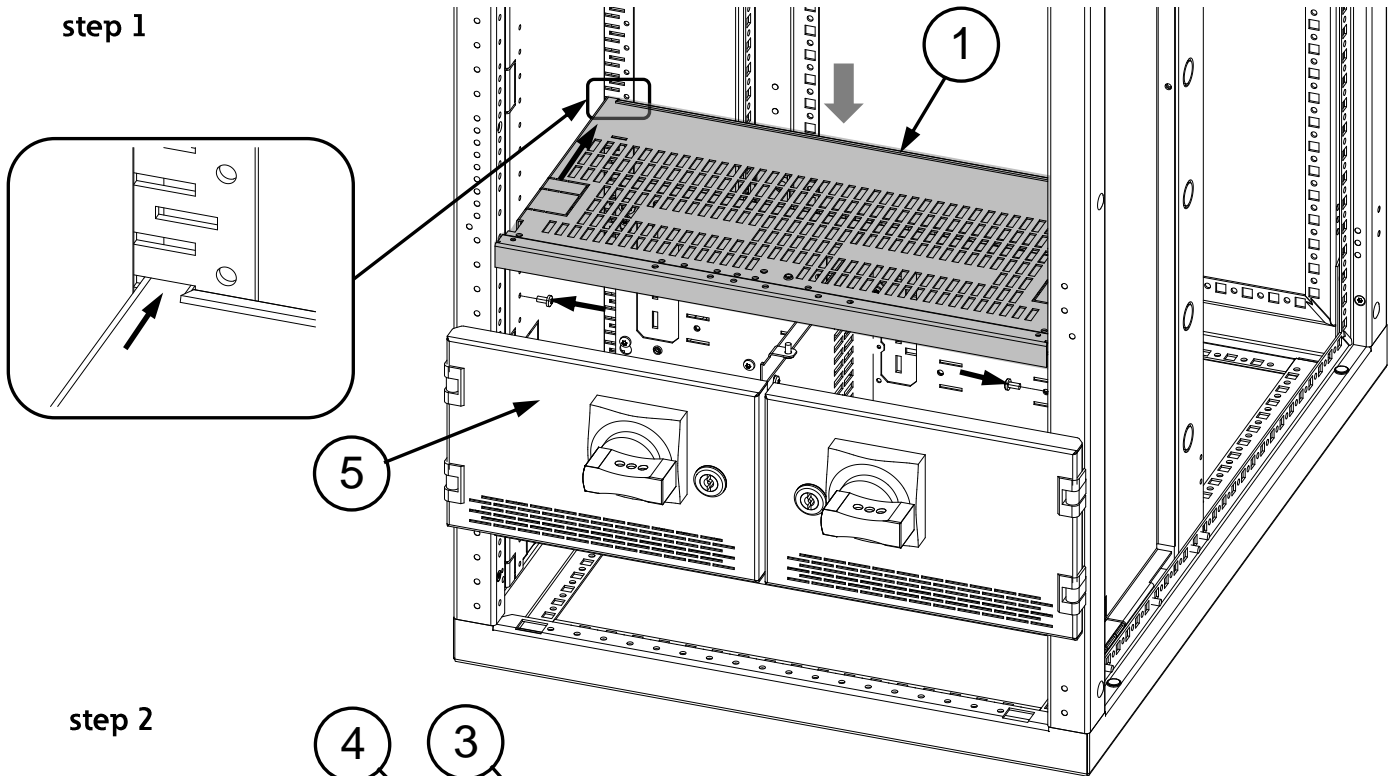

step 2

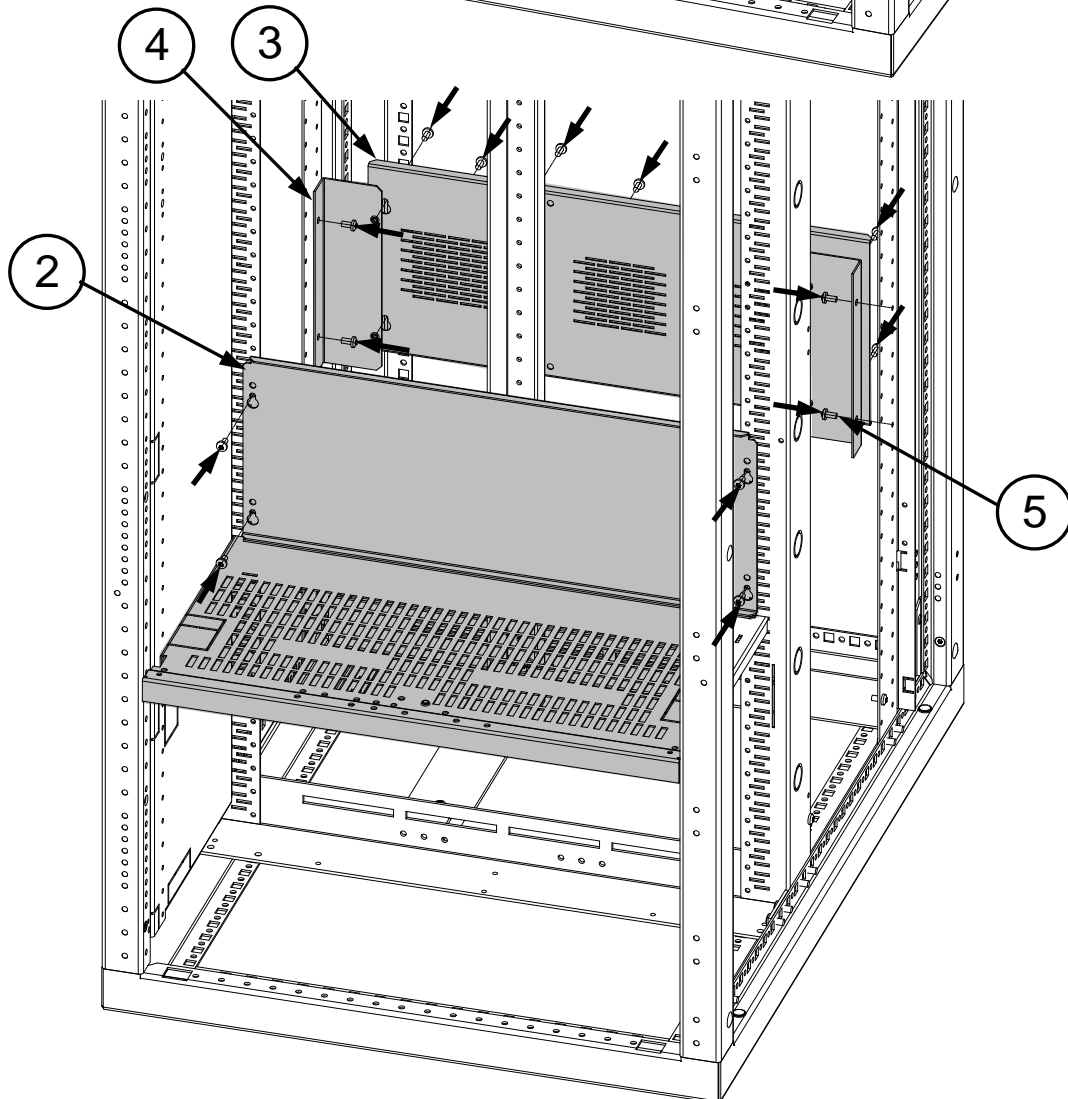

XTPFUUHP-DF

170940194

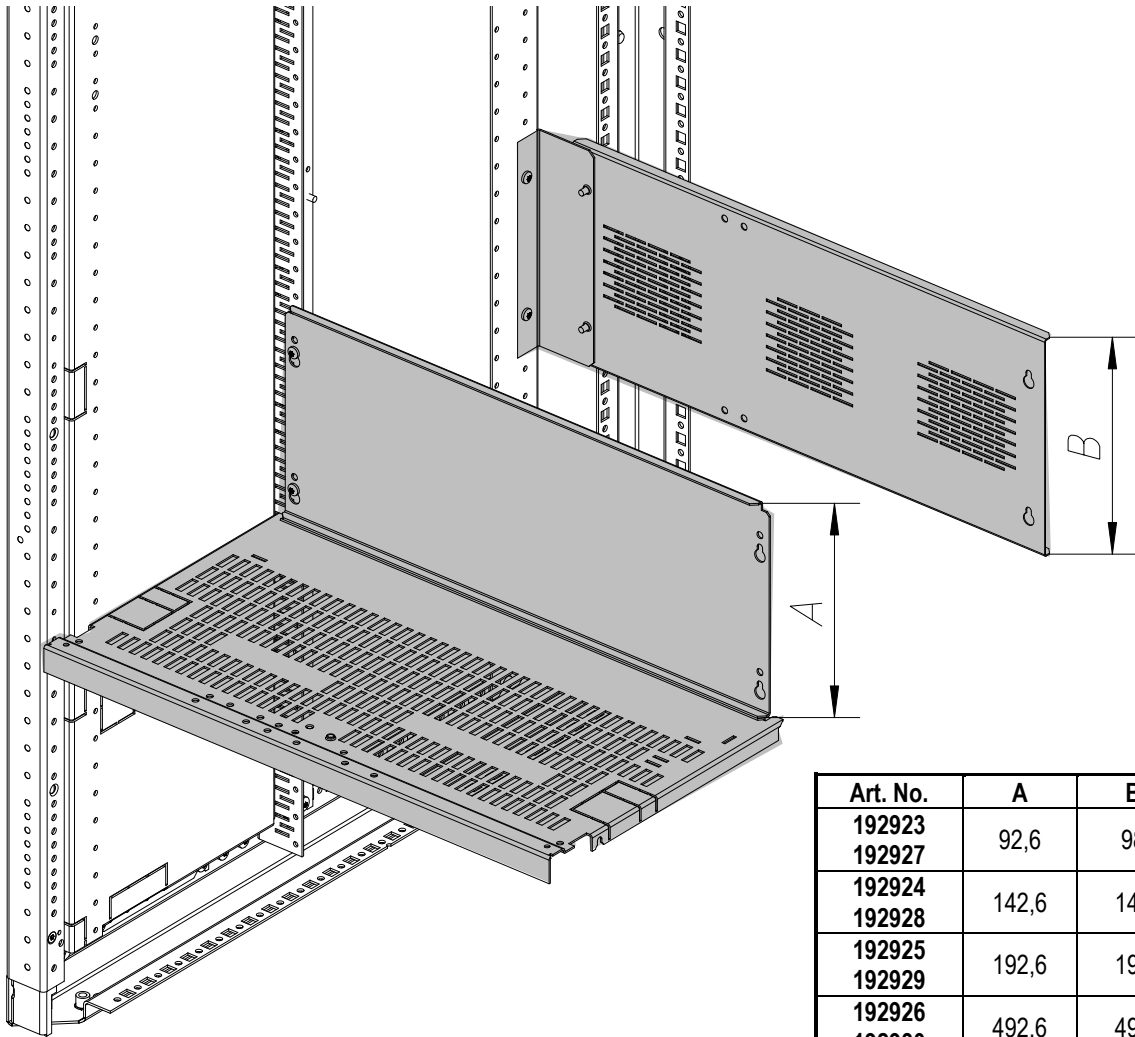

Art. No.	A	B
192923	92,6	98
192927	92,6	98
192924	142,6	148
192928	142,6	148
192925	192,6	198
192929	192,6	198
192926	492,6	498
192930	492,6	498

